



# Trussed Rafter

## Technical Manual

CI SFB	(27.9)	X12

March 2004



## Your Constructive Partner

Wolf Systems was formed in 1988 as an integral part of the Austrian based Johann Wolf Group's expansion into the world roof truss systems market, offering an innovative package including:

- Market leading, user-friendly software
- Long-term fair pricing
- New standards of customer service



The development of sophisticated design and technical facilities has placed Wolf in a commanding position amongst its competitors. This is largely due to our advanced timber roof design, manufacturing and management software. All software is user-friendly and very stable allowing detailed working drawings to be produced easily.



Wolf Systems have now added their expertise and knowledge into other products and services, which compliment trussed rafters. These include our easi-joint metal web floor system and KeyBuild Timber frame software, which is marketed through our Keymark subsidiary. We support clients with that special degree of flexibility and innovation that has characterised our success.

## Mission Statement

Our mission is to assist customers in achieving industry-leading status. We will provide the most advanced software and efficient nailplate products backed by relevant design services, machinery and other assistance. Wolf Systems will be consistently ethical in applying technical and industry standards and maintain exemplary quality at all times.



## Contents

1	Introduction	13	Handling and storage	20	Fixings: anchorage, wallplate positions, care in preparation
2	Technical data	14	Arrangement of roofing styles		Application details
3	Common trussed rafter shapes		Some structural features explained	21	Fixings: straps and clips
4	Truss loadings	16	Standard stability bracing		Application details
5	Typical eaves details		Mono-pitch trussed rafters	22	Fixings: shoes and hangers
6	Attic trusses	17	Standard stability bracing		Application details
7	Common roof shapes		Duo-pitch trussed rafters	23	Ventilation and insulation
8	Flat top hip	18	Gable ladders, hatches and chimneys		Recommended construction
9	Overlaid hip		Recommended preparation	24	Glossary of terms
10	Typical L return	19	Water tanks	28	Information required
11	T-intersection		Recommended preparation		
12	Dogleg intersection				

**TRUSSED RAFTERS** have proved to be an efficient, safe and economical method for supporting roofs since their introduction into the UK in 1964. They are manufactured by specialised timber engineering companies, who supply to all sections of the construction industry. Developments have been extensive, and today complex roofscapes are easily formed with computer designed trussed rafters.

With the continuing trend toward individualism in domestic house styling, let alone the reflection of this in new inner city estates, the facility to introduce variations to the standard designs is vital. The provision of many character differences by designing and then constructing L returns, doglegs and hips for example, satisfies the inherent need for individuality at affordable prices.

Economical roofing solutions for many commercial, industrial and agricultural buildings; hospitals, army barracks and supermarket complexes, are achieved by the expeditious installation of trussed rafters.

Experienced roof designers and trussed rafter manufacturers are therefore in an ideal position to assist the architect or specifier in achieving affordable solutions throughout the building industry. Simply provide a brief sketch or description of that being considered, including alternatives, and we will do the rest. The whole roof is designed and specified using state-of-the-art computer aided technology supplied by **Wolf Systems**. We can also arrange for one of our specialists to visit and advise you.

This technical manual highlights some of the basic structural arrangements and assembly information you may require. In addition, we can offer technical expertise and experience in a comprehensive advisory service to clients, from initial sketch to completed trussed rafters.

# Technical Data

## Design

Trusses are designed in accordance with the current Code of Practice, which is BS 5268: Part 3, and the relevant Building Regulations.

## Spans

Standard trusses can be designed up to 11 metres in 35mm timber, and 15 metres in 47mm timber. Spans in excess of these can be designed but are often supplied as multiple trusses fixed together.

## Pitches

It is more economical to standardise the range of pitches between 15 & 40 degrees, however, trusses can be supplied outside this range. Care should be taken when specifying because deflection problems may arise with eg. very shallow pitches.

## Eaves Overhangs

Any overhang can be supplied to suit the customer's requirements. NB. Very large overhangs may cause the trusses to be uneconomical.

## Spacing

Trusses are usually spaced at 600mm, but can also be positioned at 450mm or 400mm to support heavier loads.

## Timber

We use timber which is kiln dried and stress graded, and which complies with current European and British Standards.

## Preservation

Trusses may be treated with one of the new waterborne solutions, or with non-corrosive spirit-based organic solvents. Copper Chrome Arsenate and similar treatments, are not recommended.

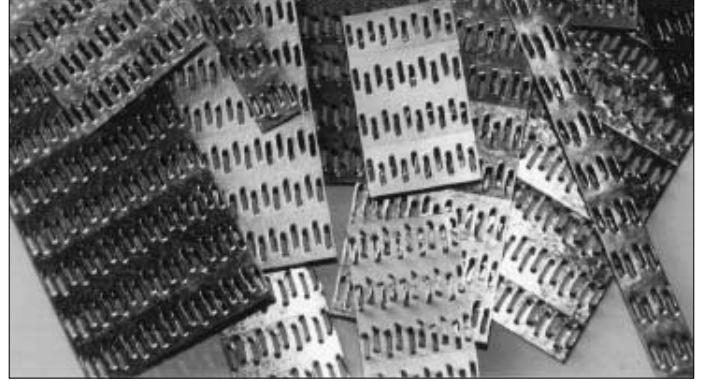

## Nailplates

We use and recommend Wolf 100 nailplates which are precision punched 1mm gauge metal plates with integral teeth and are manufactured from structural grade galvanised mild steel to BS 10147 Fe E 220 G275. They carry a 60 year performance warranty and are covered by Certificate No.89/2290 issued by the British Board of Agrément.



Also available and often specified for spliced timber joints, are the Wolf 125 nailplates in 1.25mm galvanised mild steel.

1.5mm gauge nailplates, imported from Austria, are available for heavier timber constructions requiring longer teeth. They are supplied in limited pre-determined sizes. Wolf 15N are galvanised: Wolf 15NE are stainless steel for specific applications only.

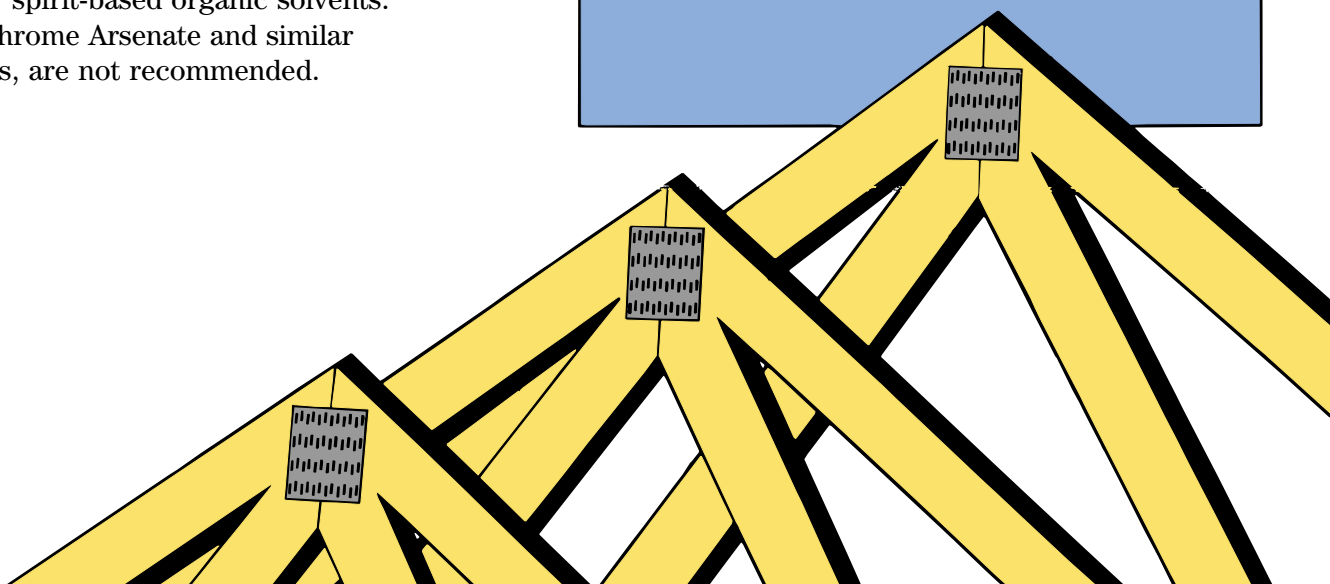
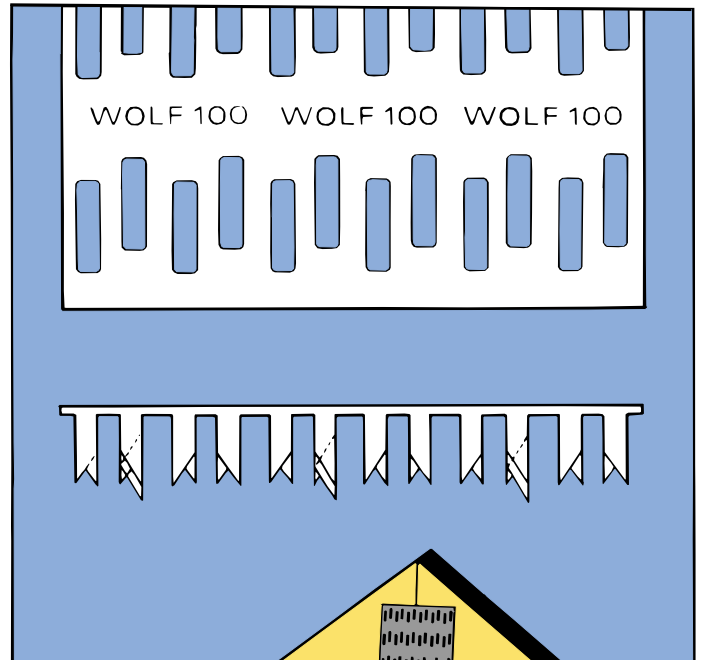

# Some common trussed rafter shapes

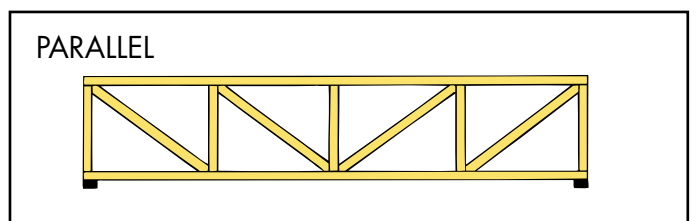
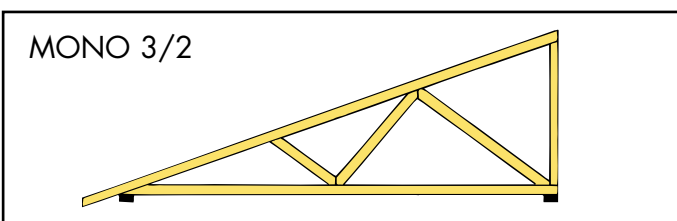
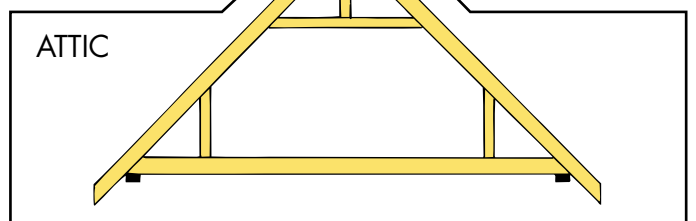
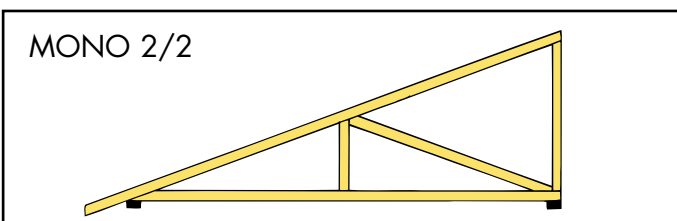
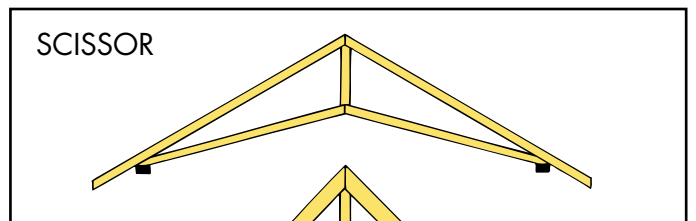
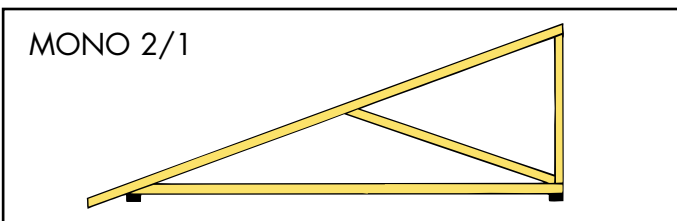
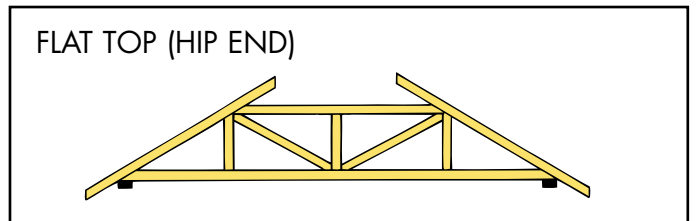
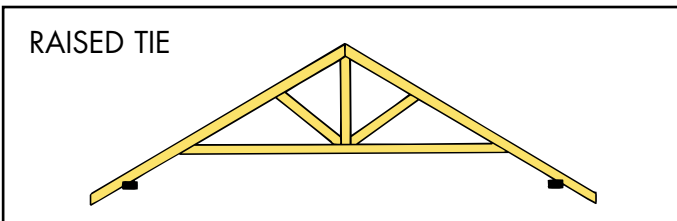
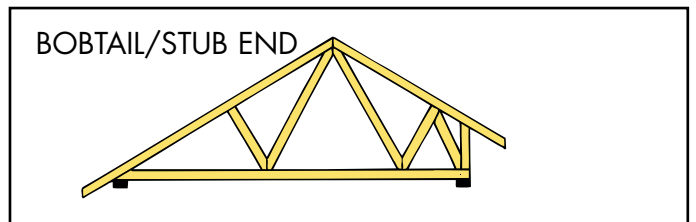
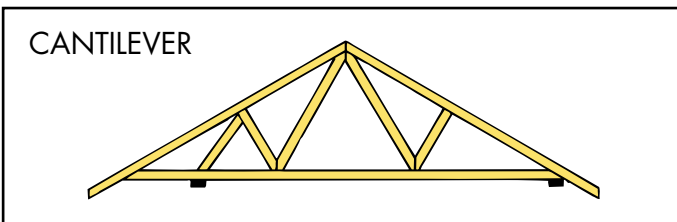
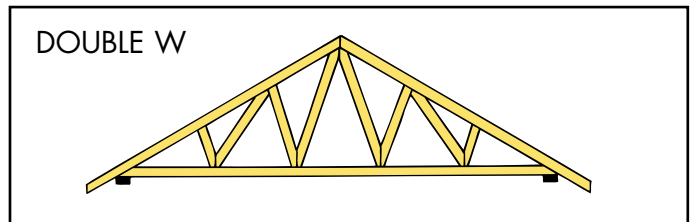
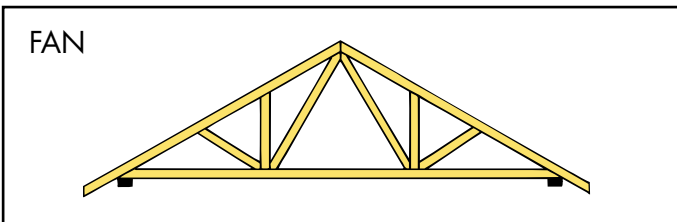
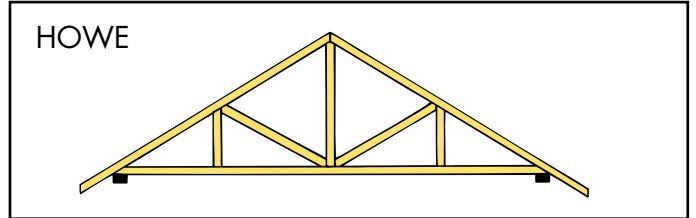
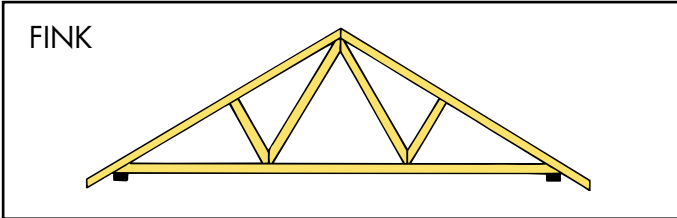
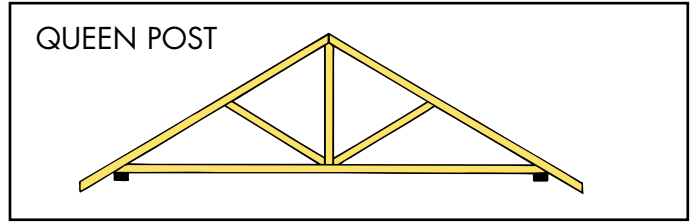
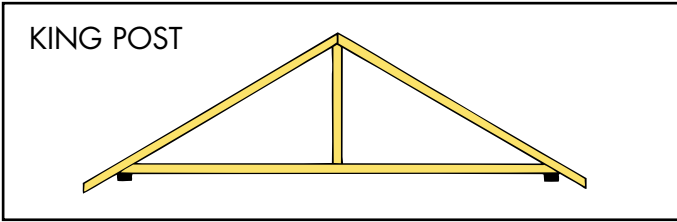

# Truss Loadings

Imposed loads in accordance with BS 6399.

## RAFTER LOADS

**Long Term Loads:** For standard concrete interlocking tiles the loads are as follows:

Tile weight	575 N/m <sup>2</sup>
Truss self weight	75 N/m <sup>2</sup>
Battens & felt	35 N/m <sup>2</sup>
	685 N/m <sup>2</sup>

Where a rafter bay forms part of the room (in raised tie and attic trusses) an additional load of 250 N/m<sup>2</sup> is added for the ceiling finishes.

**Medium Term Loads:** For small buildings ie. total floor area less than 200m<sup>2</sup> and where roof shape calculations have not been made, the 0 - 30 degrees site snow load is 750 N/m<sup>2</sup>. This reduces for pitches greater than 30 degrees, reducing to zero at 60 degrees.

**Short Term Loads:** A man point load of 675 N (900 N x 75% for load sharing) is applied to rafters up to 30 degrees. However, experience has shown that for standard truss configurations designed for 750 N/m<sup>2</sup> snow loads, the rafter man point load is not a critical load case.

**Wind Loads:** Wind loads are calculated in accordance with CP3: Chapter V part 2, all structures are assumed to be of Class B.

## CEILING TIE LOADS

Long Term Loads: These are as follows:

Truss self weight	75 N/m <sup>2</sup>
Plaster board	175 N/m <sup>2</sup>
Imposed load (loft storage)	250 N/m <sup>2</sup>
Total long term load	500 N/m <sup>2</sup>

Tank load at 2 node points normally 450 N per node (see tank details on page 19).

**Short Term Loads:** A man point load of 675 N (900 N x 75% for load sharing) is applied at a point likely to produce the highest stress in the ceiling tie.

## ADDITIONAL LONG TERM LOADS FOR ATTIC TRUSSES

The floor area will be loaded as follows:

Domestic imposed load	1500 N/m <sup>2</sup>
Partition loads	250 N/m <sup>2</sup>
Truss self weight	75 N/m <sup>2</sup>
Plaster board	175 N/m <sup>2</sup>
Floor boarding	250 N/m <sup>2</sup>
	2250 N/m <sup>2</sup>

Point loads are applied to the nodes at the side of the room for the plaster board of 250 N/m<sup>2</sup>. x height at the side of the room. A load of 250 N/m<sup>2</sup> is applied to rafters where they form part of the room.

## WolfChord Composite Beams

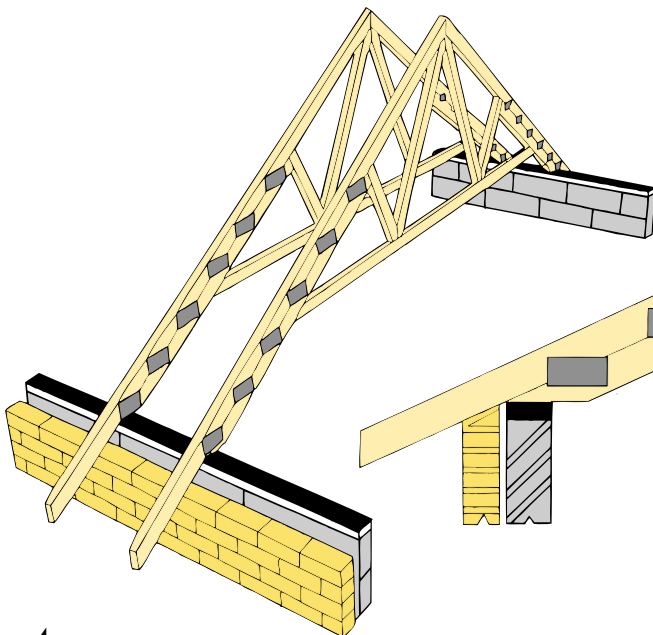

Nailplates used to secure the two timber members together are evenly distributed over the length.

WolfChord Composite Beams generally consist of two timbers plated together to form a deeper section. The method of fixing is to cut away the lower member so that it rests on the wallplate. It should be secured to wallplates by using either glide shoes or truss clips.

# Typical eaves details

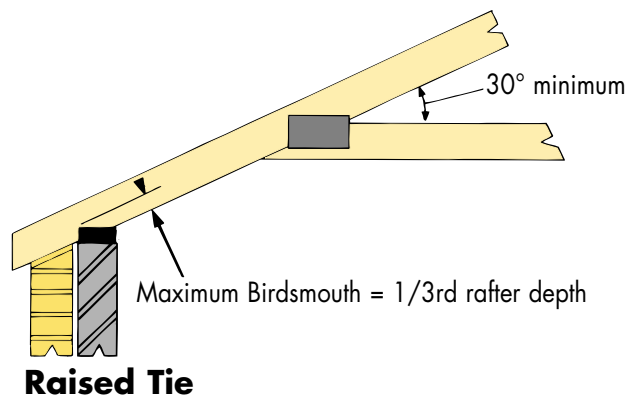
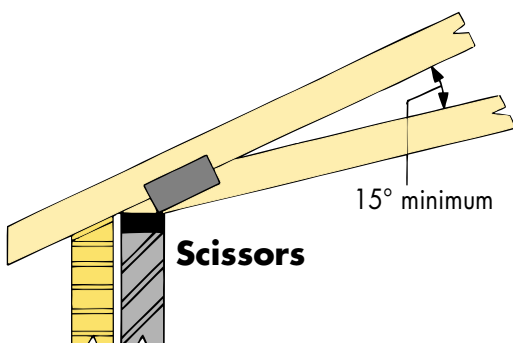
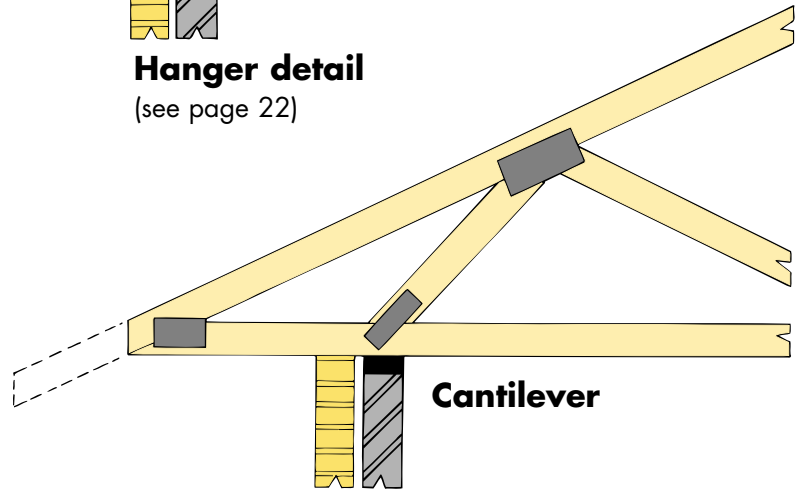
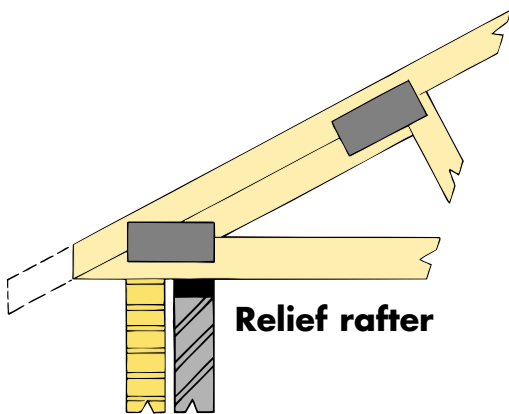
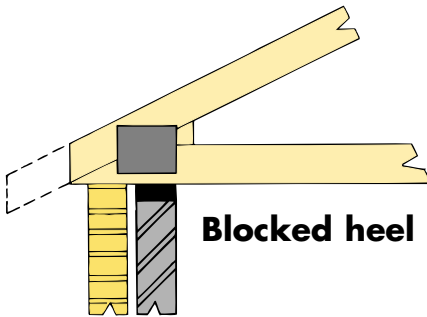
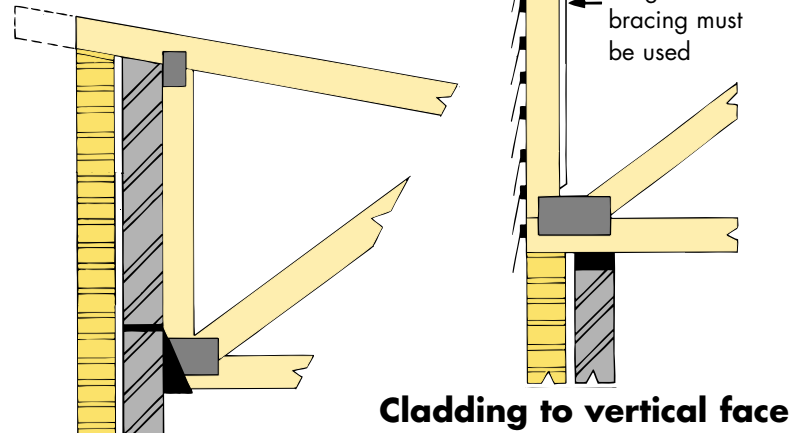
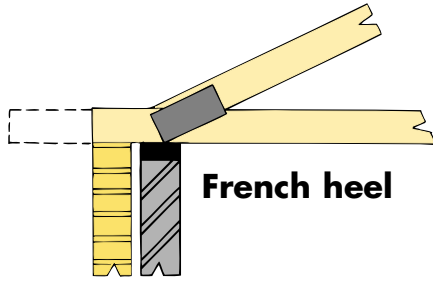
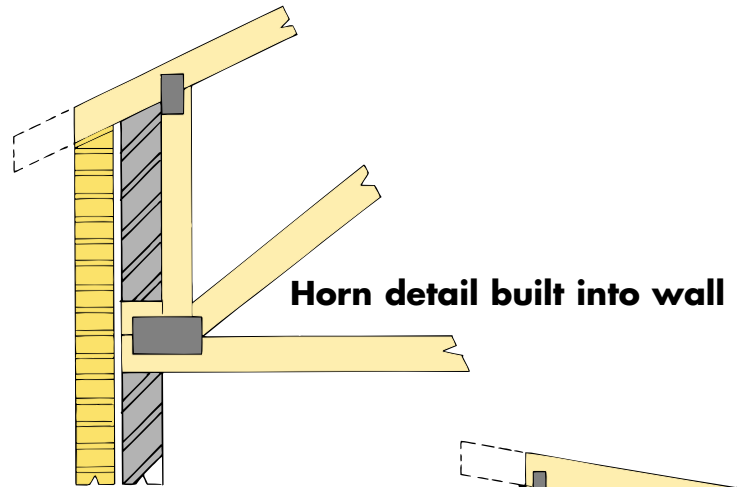
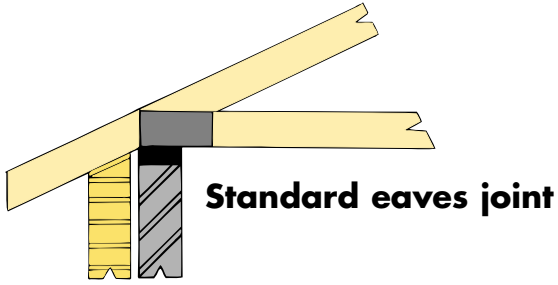

# Attic trusses

Roof space using attic trusses can achieve up to 50% more living area. Provision for creating extra rooms may be incorporated at the initial stage for immediate use, or conversion later into living accommodation to suit the house owner's changing circumstances. No extra strengthening of the trusses is required, although a central support might be needed for very large spans.

## Spacing

Loadings to attic trusses are usually greater than normal trusses (see page 4). Consequently, timber sizes are larger and spacings may be reduced to 450mm centres.

## Stairwells, Rooflights and Dormers

Attic trusses will provide living accommodation in the roof space; therefore, care has to be taken with respect to stairwells, rooflights and dormers. Usually these are wider than the truss spacings, but difficulties can be overcome by grouping trusses together to form compound girder trusses on either side of the openings. Common rafters and floor joists can be supported by purlins and binders between the compound trusses. Stairwells should lie along the line of trusses to avoid cutting across them, and similarly, to avoid too many compound trusses, dormers and rooflights should be situated opposite each other.

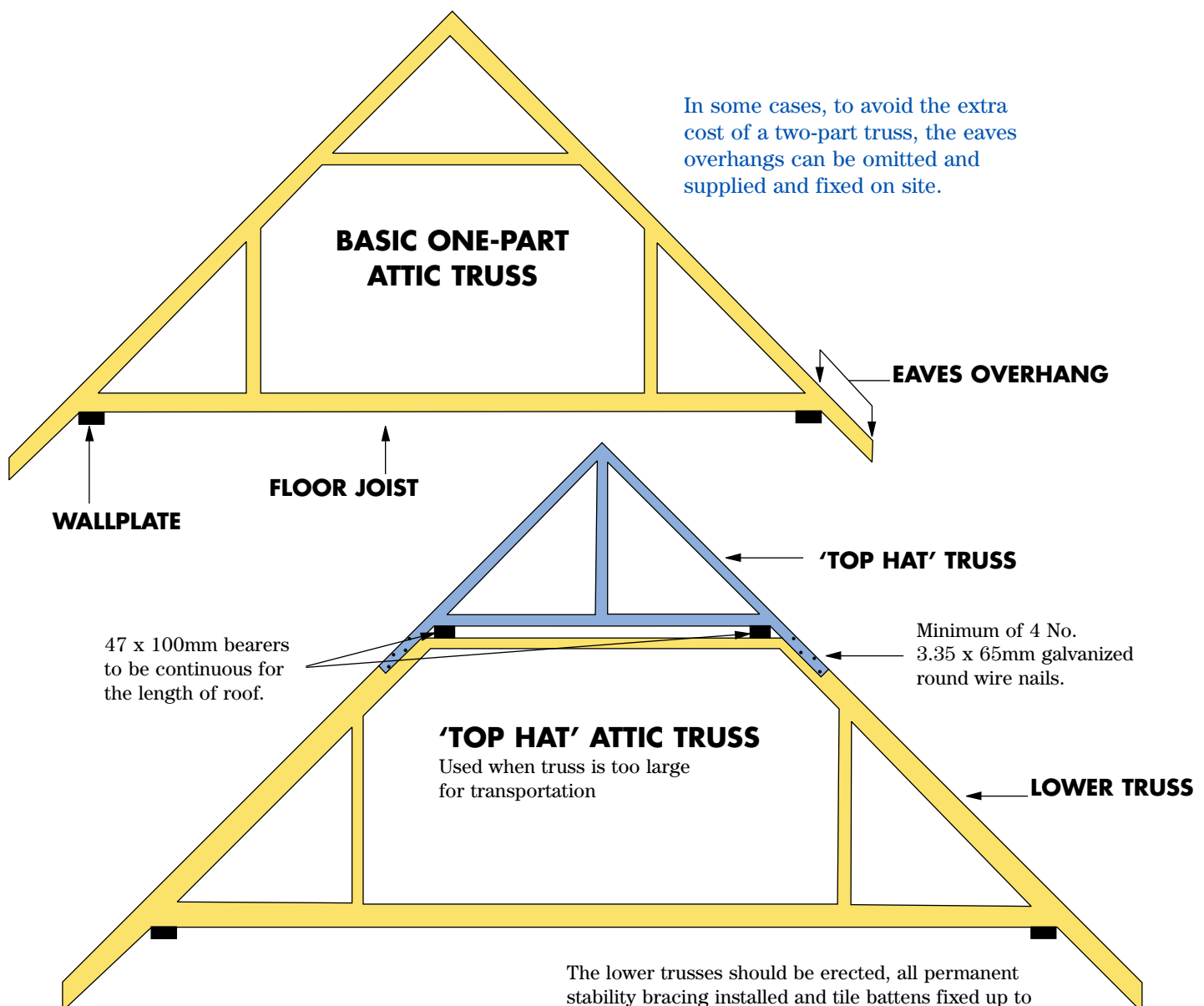

The lower trusses should be erected, all permanent stability bracing installed and tile battens fixed up to the lap position of the 'top hat' truss. The resulting structure then forms a safe, rigid working platform for the erection of the 'top hat' trusses. Tiling or loading of the base trusses should not proceed until the 'top hat' trusses are fully installed and braced.



# Common roof shapes

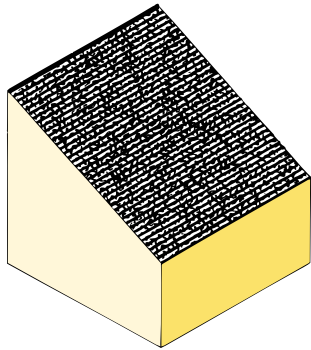

**Mono-pitch**

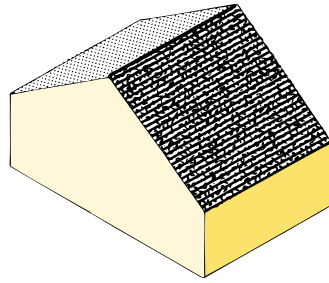

**Duo-pitch**

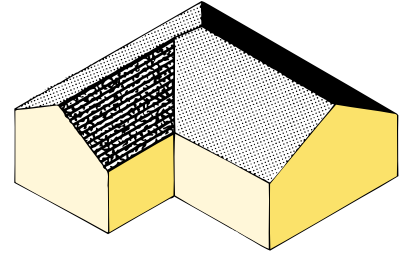

**L return**

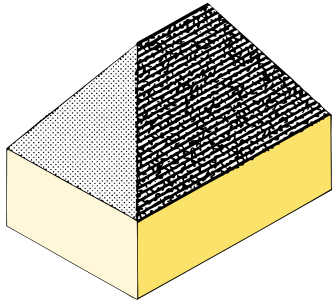

**Hipped**

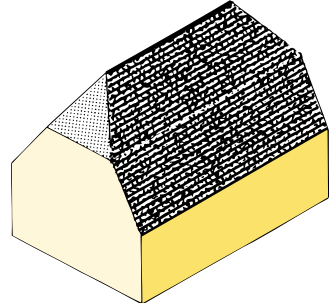

**Dutch or Barn hip**

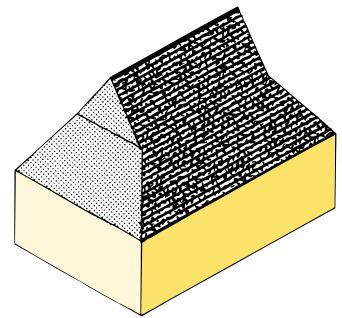

**Gablet**

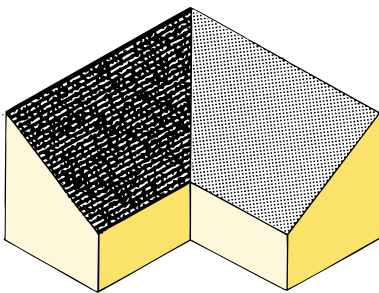

**Mono L return**

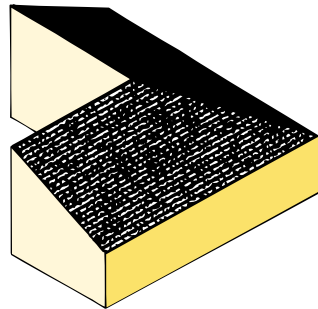

**Mono L return/Mono hip**

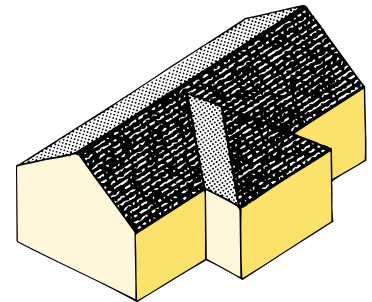

**Overlaid hip**

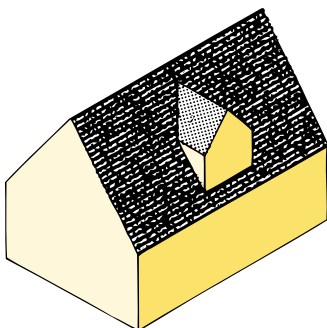

**Dormer**

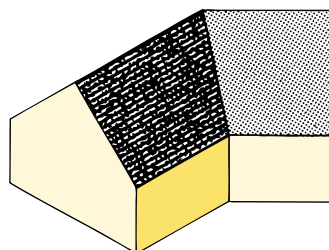

**Dogleg**

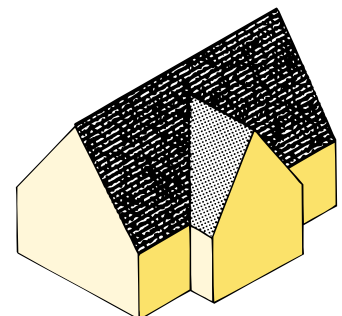

**T-intersection**

# Flat top hip

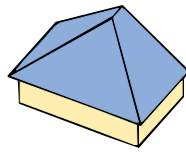

The horizontal top chords to the flat top trusses are to be well braced together to resist lateral buckling

**Infill Ceiling Joists**

**Infill Jack Rafters** to be a minimum of 25mm deeper than trussed rafter members to allow for birdmouthing at wallplate

**Mono Pitch Trusses** supplied with extended rafters for site cutting to suit hip boards

**Noggings** to be nailed to ceiling joist and side of jack rafter

**Hip Boards** to be birdmouthed over the compound girder of flat top trusses and over the wallplate

**Compound Girder of Flat Top Trusses** permanently fixed together

**Standard Trusses to Main Roof**

**Flat Top Trusses** supplied with extended rafters for site cutting to suit hip boards

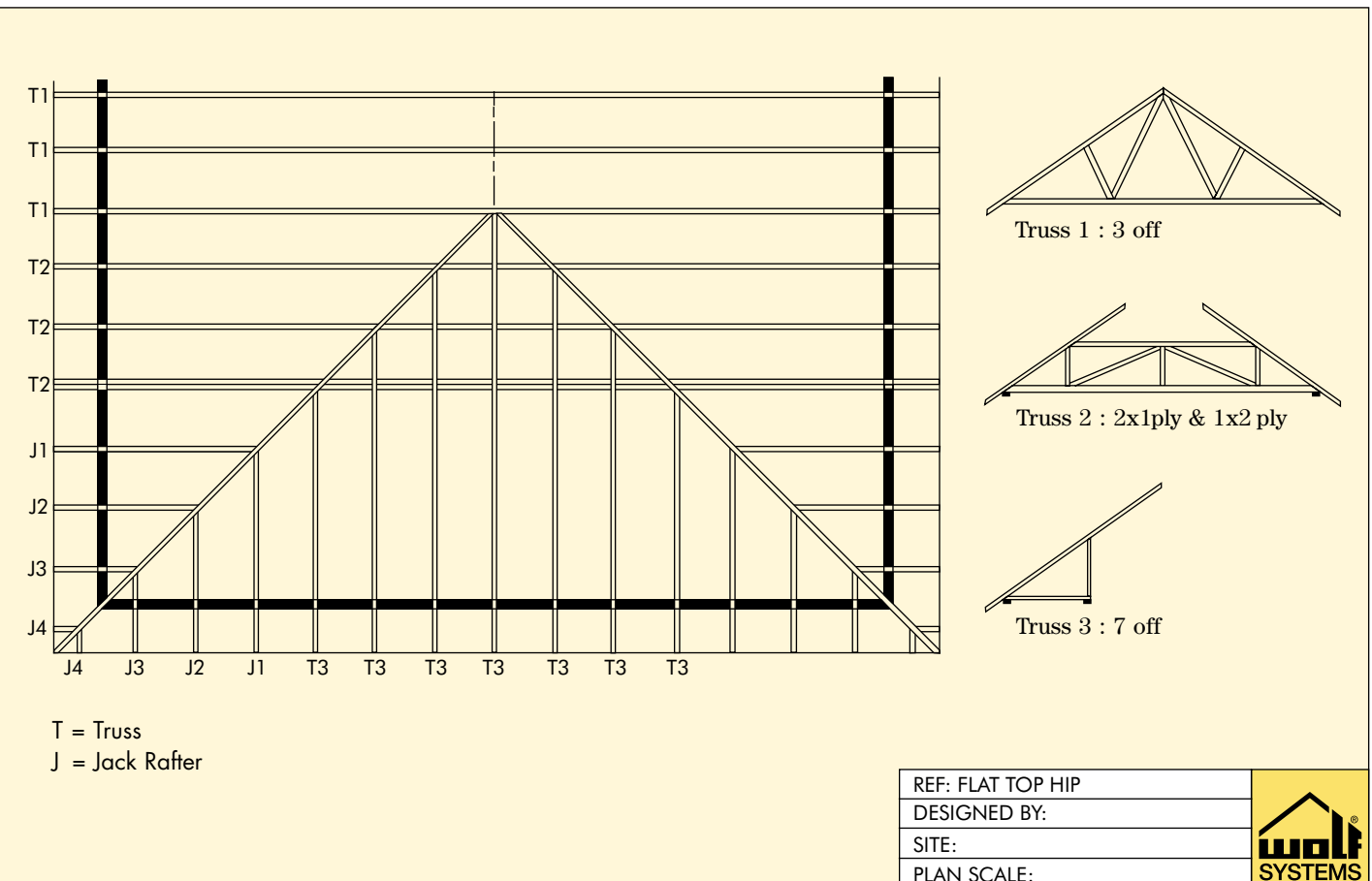

# Overlaid hip

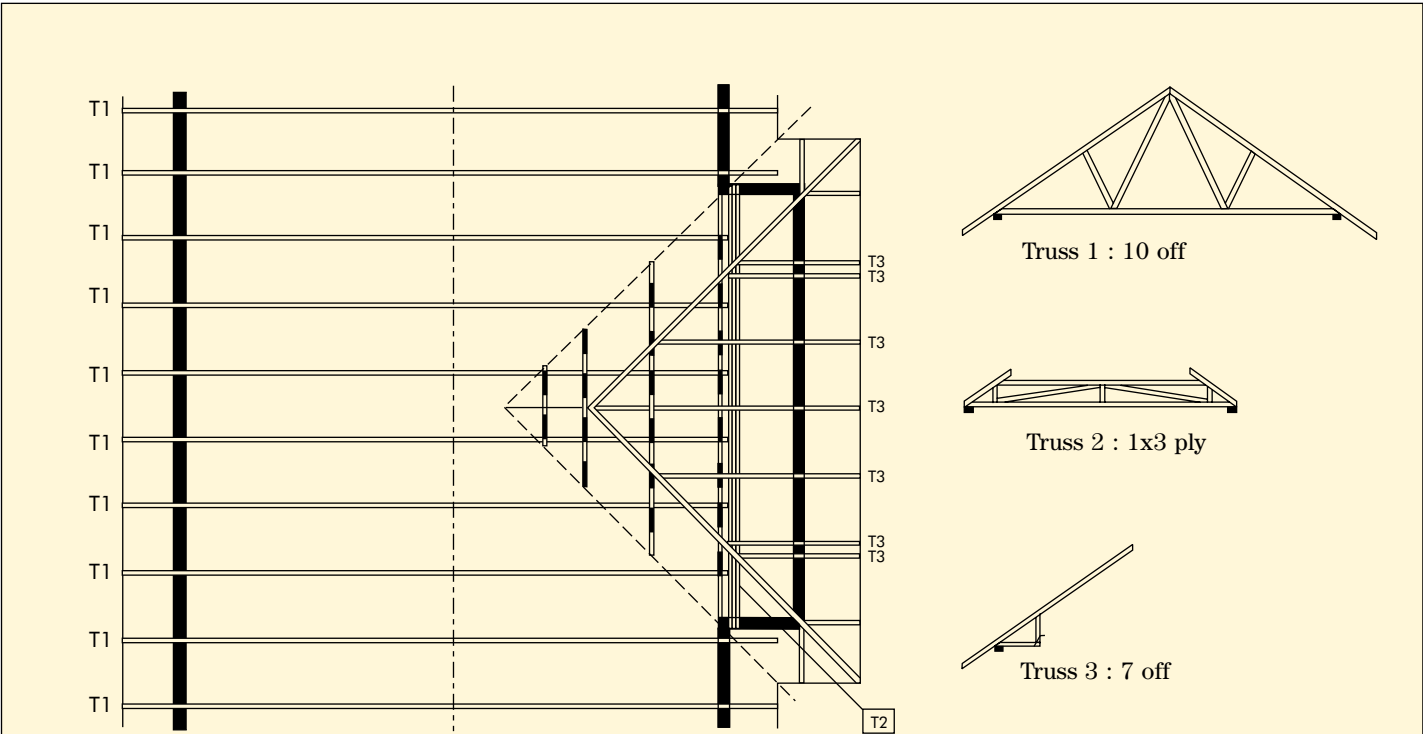
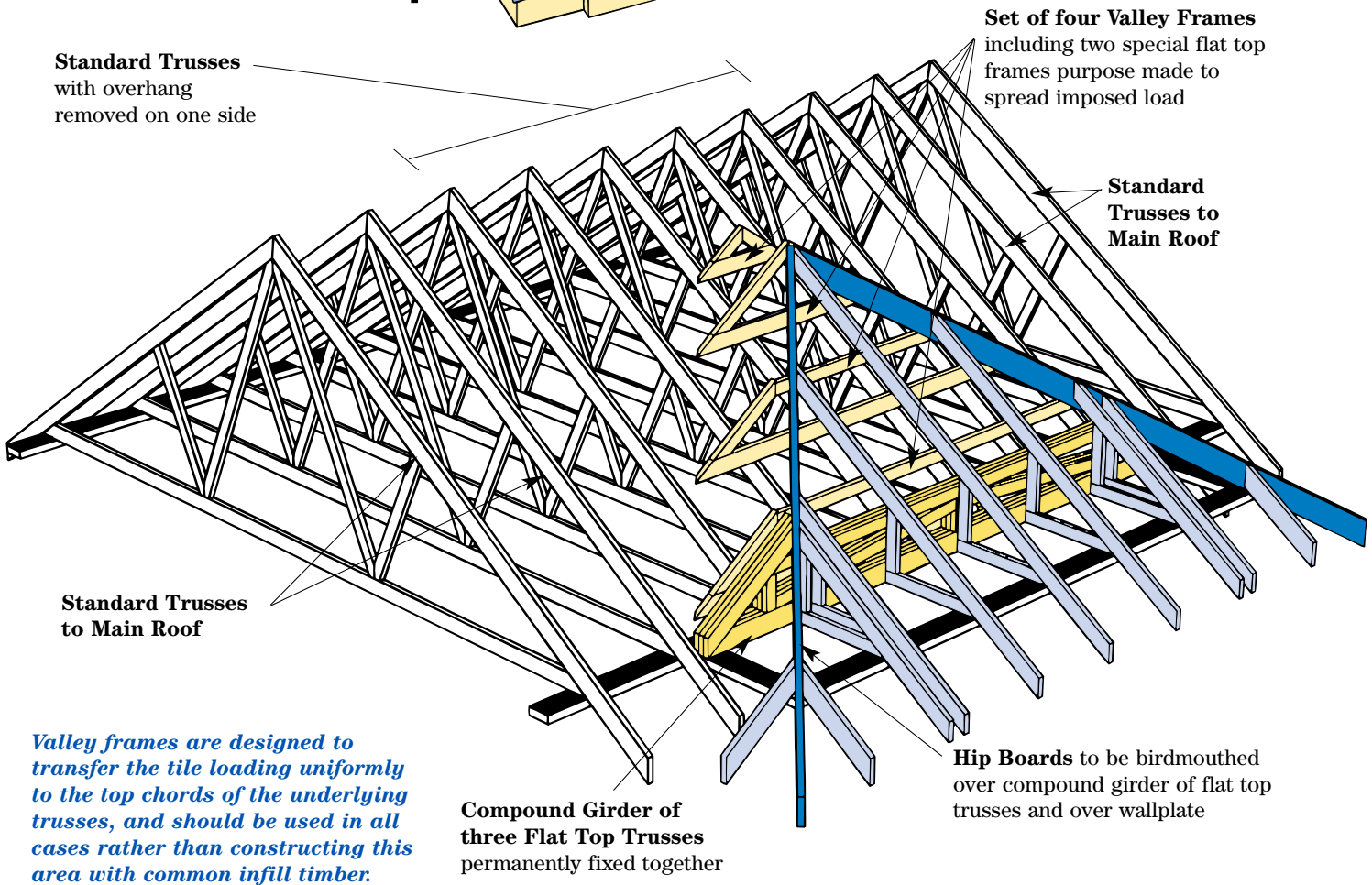
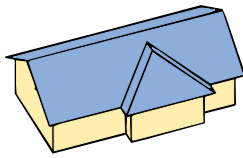

REF: OVERLAID HIP
DESIGNED BY:
SITE:
PLAN SCALE:



# Typical L return

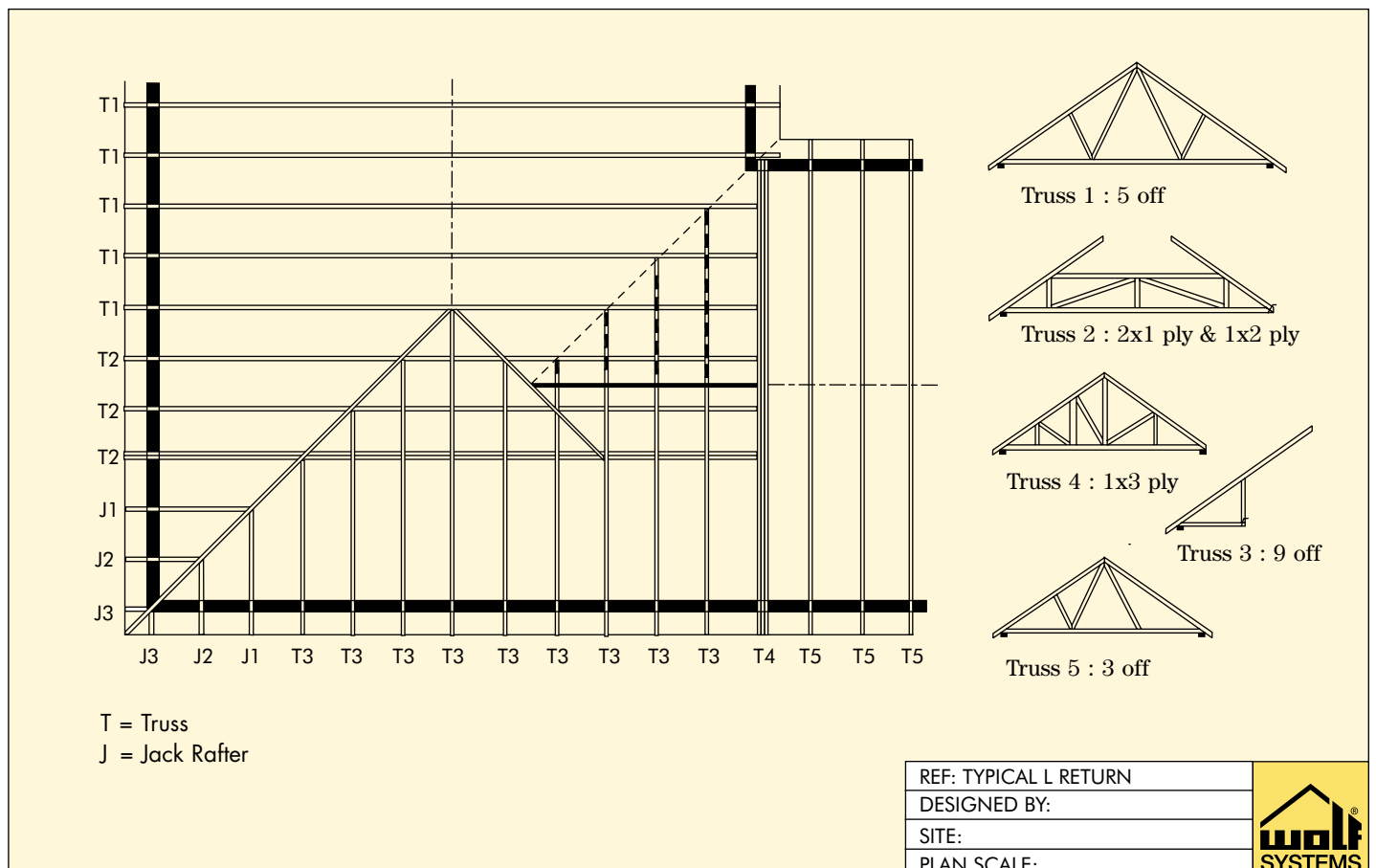
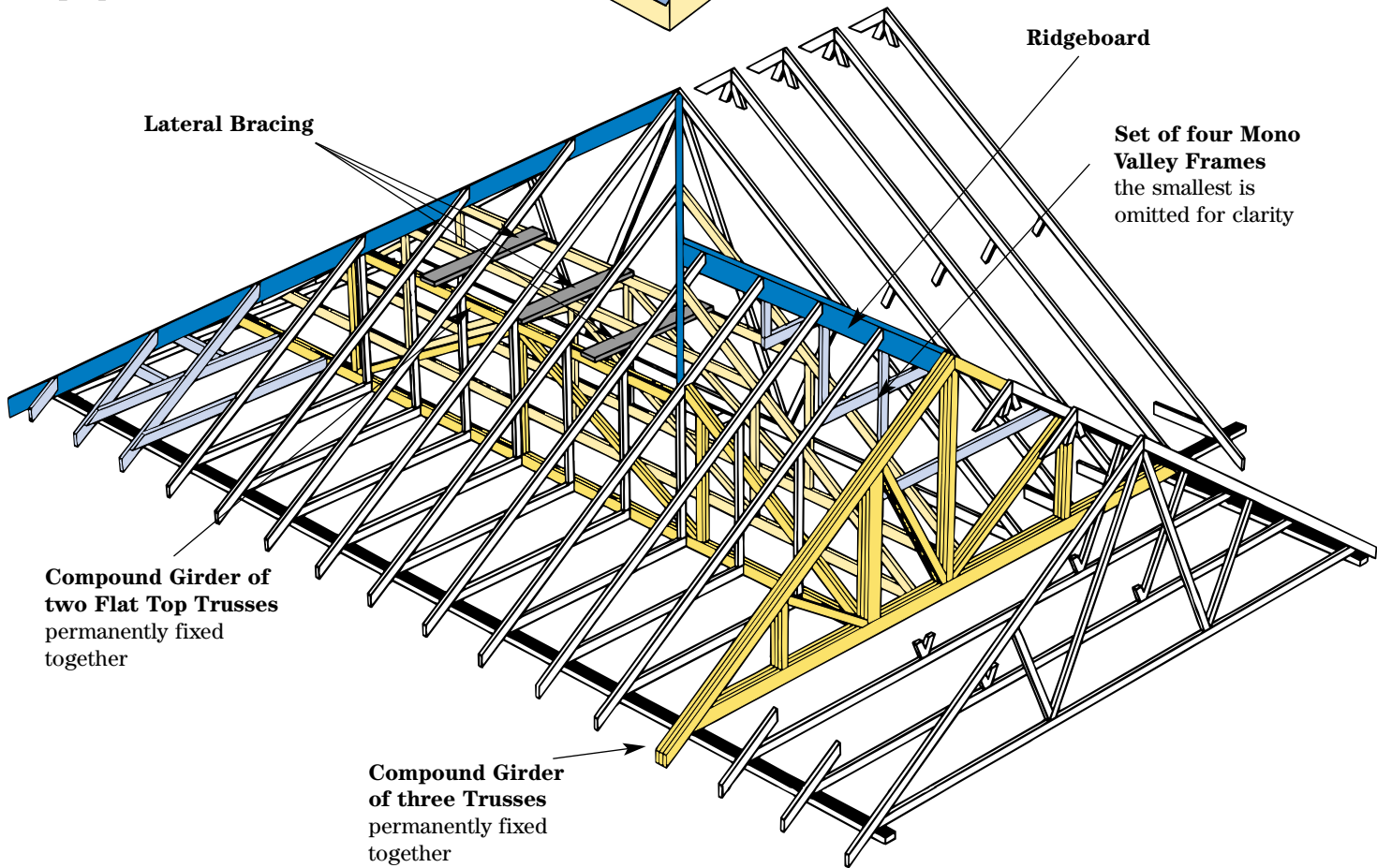
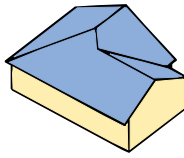

# T-intersection

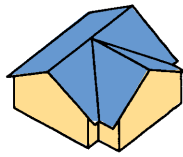

Standard Trusses with overhang removed on one side

Set of three diminishing Valley Frames nailed directly on to the main trussed rafters. The internal members of the valley frames are omitted for the sake of clarity

Standard Trusses to Main Roof

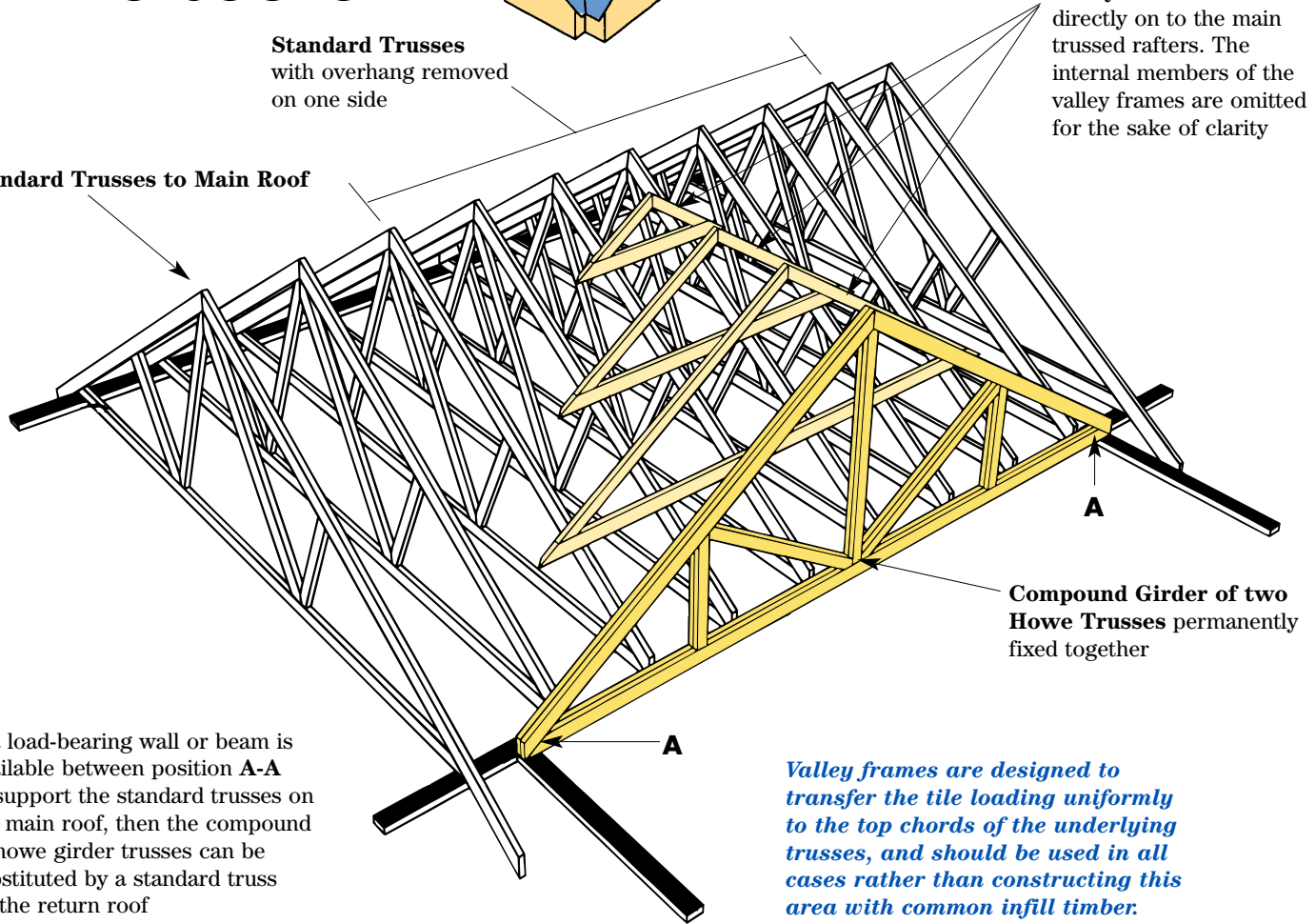

Compound Girder of two Howe Trusses permanently fixed together

If a load-bearing wall or beam is available between position A-A to support the standard trusses on the main roof, then the compound of howe girder trusses can be substituted by a standard truss on the return roof

*Valley frames are designed to transfer the tile loading uniformly to the top chords of the underlying trusses, and should be used in all cases rather than constructing this area with common infill timber.*

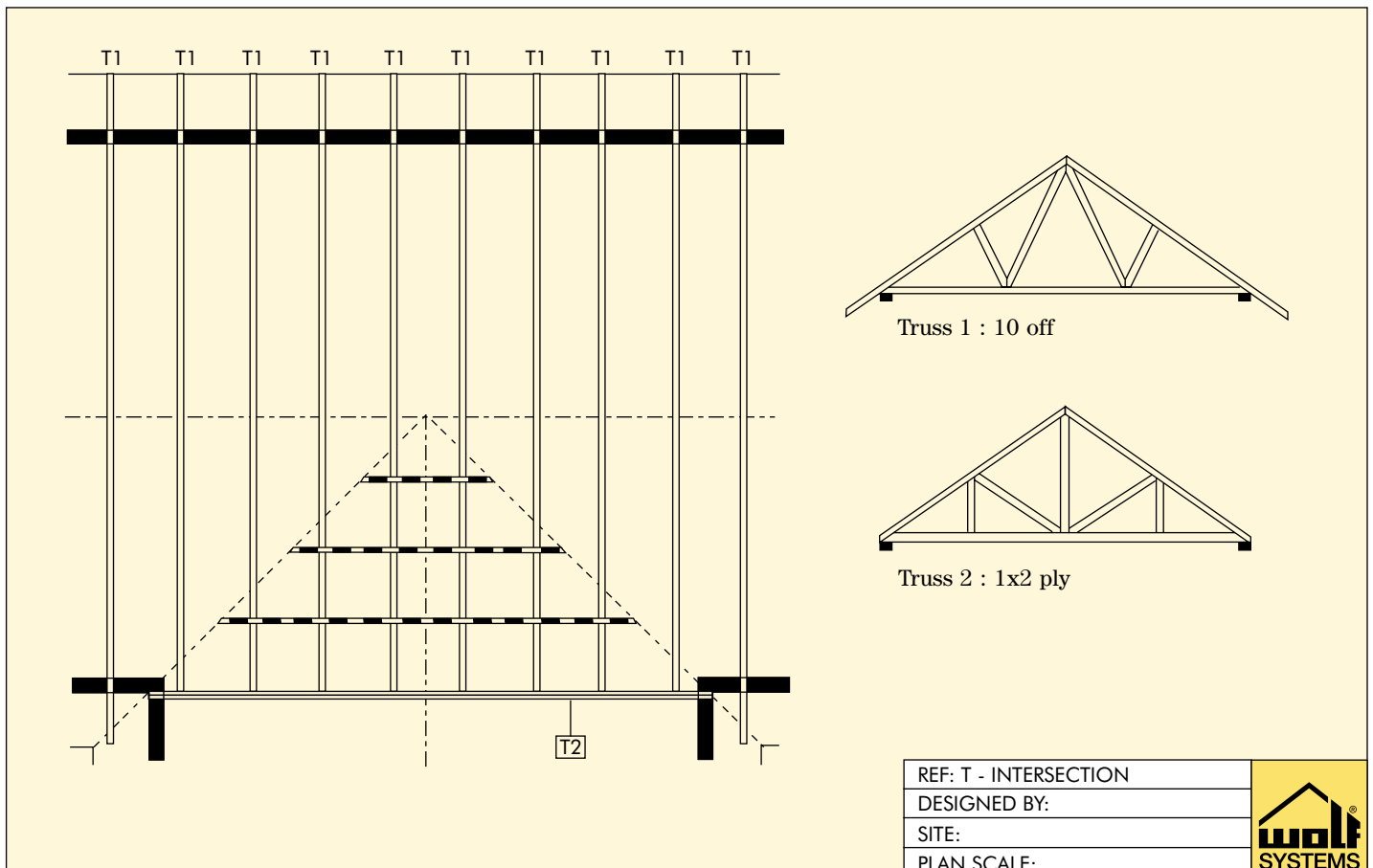

REF: T - INTERSECTION  
 DESIGNED BY:  
 SITE:  
 PLAN SCALE:



# Dogleg intersection

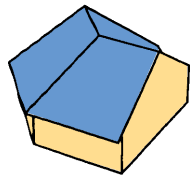

The five roofscapes illustrated in this section are those most commonly constructed. There are many other ways of framing hips, corners, intersections etc. with trussed rafters. Please contact us for help and specific details.

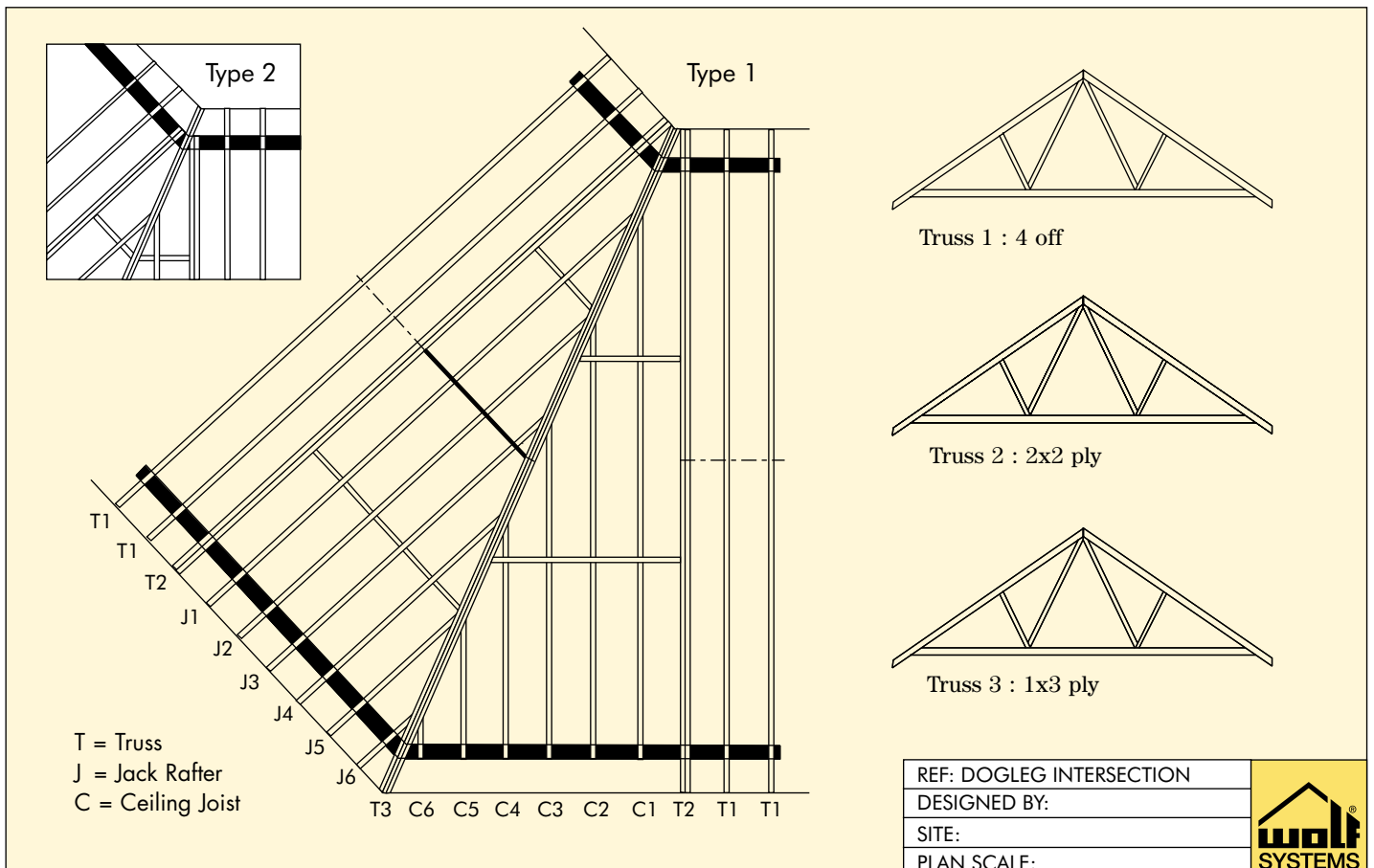
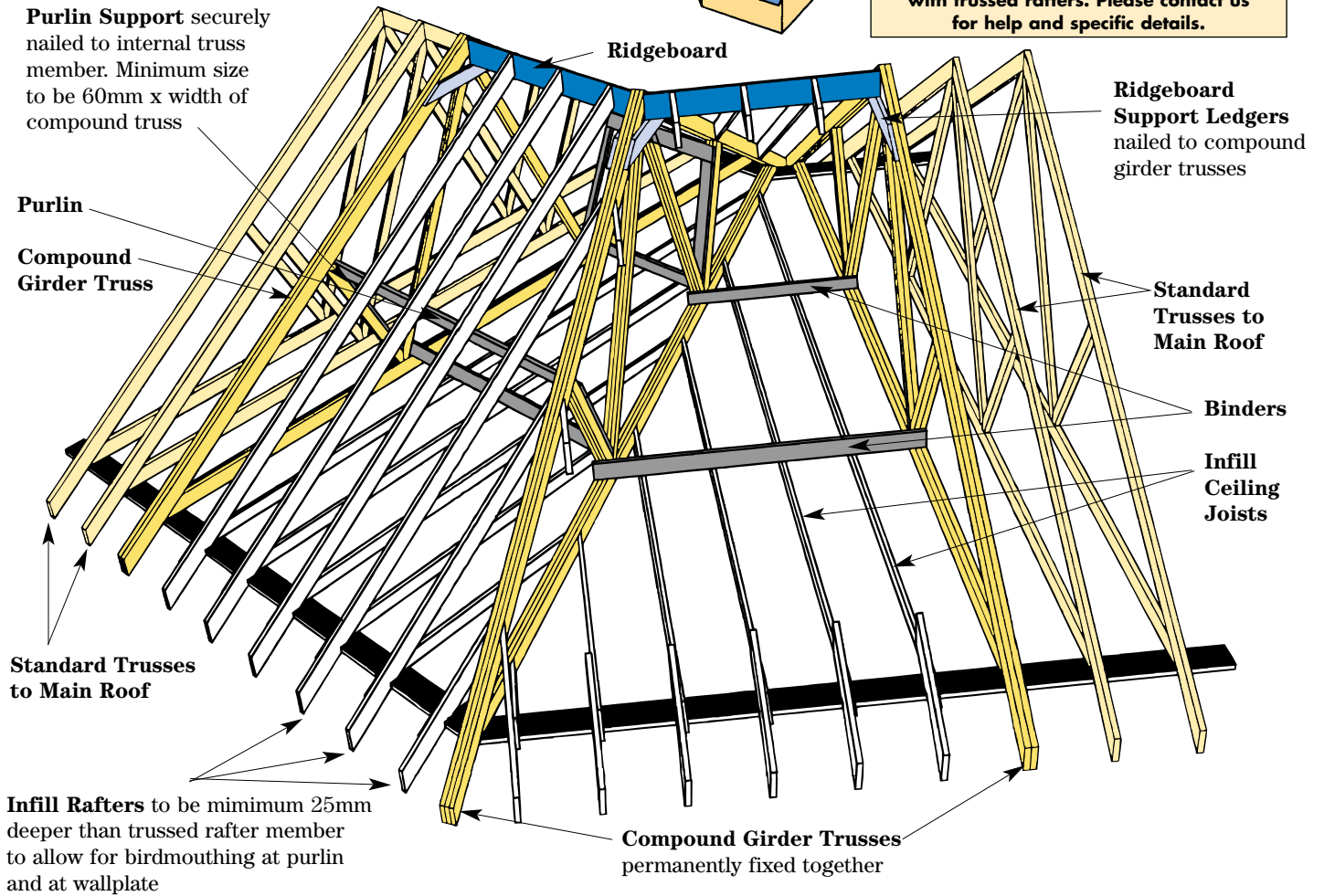

# Storage and handling on site

## HANDLING

This information shows how trusses may be handled such that no structural damage occurs. It does not infer a safe lifting method for site staff who should take note of both H.S.E. Lifting Regulations and Construction (Design and Management) Regulations 1994. Mechanical handling for unloading and erecting trusses safely is strongly recommended.

Trusses may become damaged by incorrect handling. During transportation, they may, of necessity, also be inverted. When mechanically handled, the trusses should be banded together in sets and supported when lifting utilizing a spreader bar, as shown in fig 2.

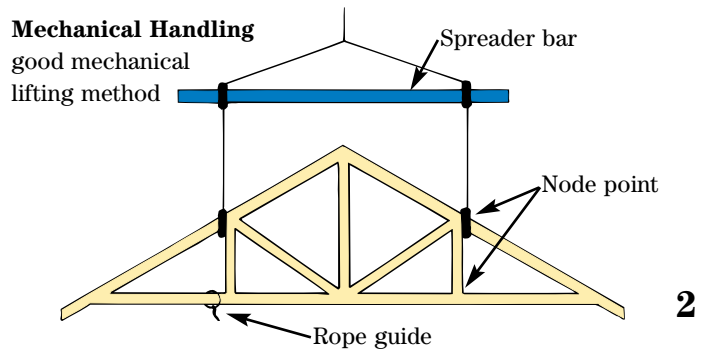
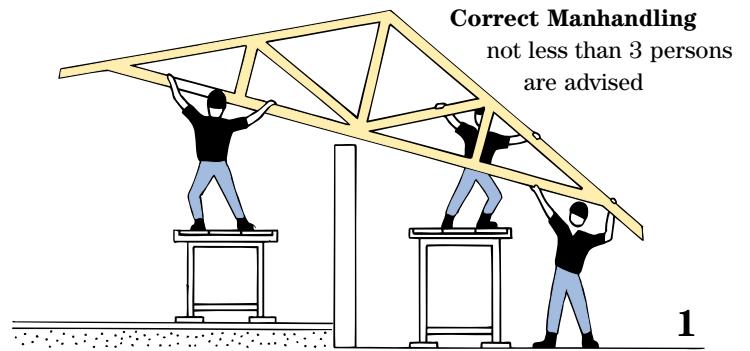

## STORAGE

It is imperative to prevent damage or deformation to trusses awaiting erection. They should be stored as illustrated (3 & 4) and protected from sun and rain. Adequate allowance must be made for ventilation.

TYPICAL TRUSS WEIGHTS	
35mm thick fink truss = 35 kg	
47mm thick attic truss = 110 kg	
3 ply 35mm thick howe girder = 160 kg	
NB: Weights given are for guidance only. For lifting and handling check actual truss weights	

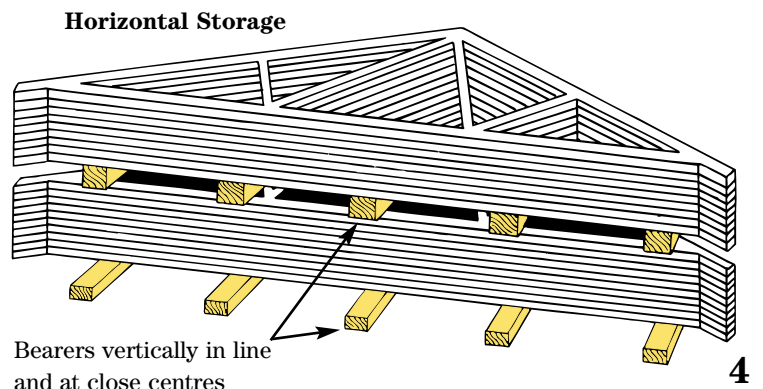
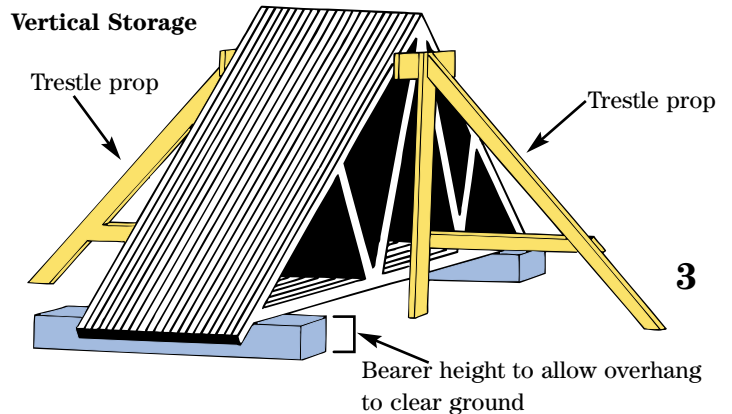

# Arrangement of roofing styles

## Some structural features explained

The variation of roofing styles possible with truss rafters is unlimited. In this illustrated arrangement, we have shown some of the more popular constructions. The application of trussed rafters is efficient, safe and economical. Produced by precision manufacturing, all structural roofing timbers can be delivered to site for immediate erection thus obviating problems with site storage and deterioration, pilfering and damage. Tiling is often completed the same week as truss rafter deliveries.

Wolf Systems computer software generates layouts similar to this, as well as full working plan-drawings. Furthermore, the Wolf System also provides structural calculations and manufacturing details, as required by Building Control authorities.

*N.B. In this layout all bracings and fixings, and some timbers have been omitted for the sake of clarity.*

QUEEN POST TRUSSES  
with infill around chimney

DUTCH OR BARN HIP

GABLE LADDERS cut to give 50mm min. clearance of chimney. They should be nailed directly to the face of the last positioned truss.

ATTIC TRUSSES WITH DORMERS & ROOFLIGHTS can achieve up to 50% more living space. Generally trusses are constructed of larger sized timbers, and spacings may be reduced.

VALLEY SET  
necessary to continue roof line at inter-sections, usually in diminishing sets.

FLAT TOP HIP

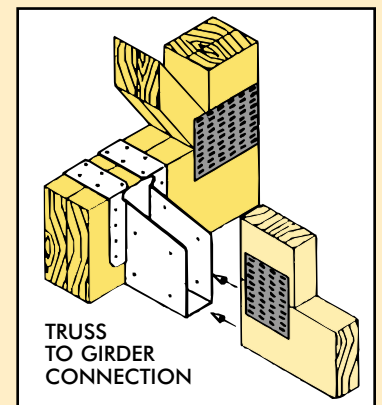
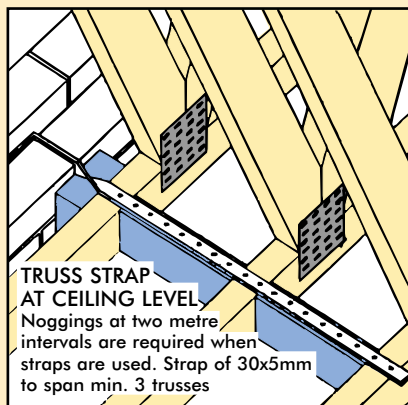



FINK TRUSSES are the most common type of truss, they are duo-pitched with the webs forming a letter W. Some of the trusses are cut away to show the water tank which is mounted on a platform with support bearers.

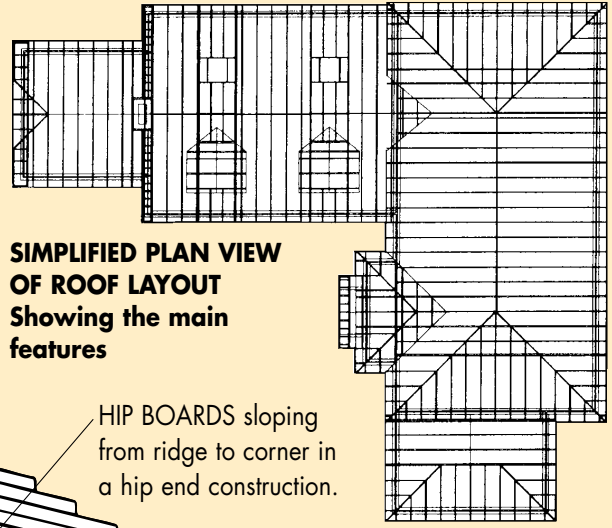

HIP BOARDS sloping from ridge to corner in a hip end construction.

FLAT TOP HIP END showing compound girder of two flat top trusses permanently fixed together, and two further single flat top trusses behind.

RAISED TIE TRUSSES OVER PORCH with incorporated gable ladder

OVERLAID HIP with set of 3 valley frames and flat top compound girder.

GABLET a vertical roof section set back from the slope of the hip end.

BARGEBOARD to conceal roof timbers, is usually secured to timbers at gable ends.

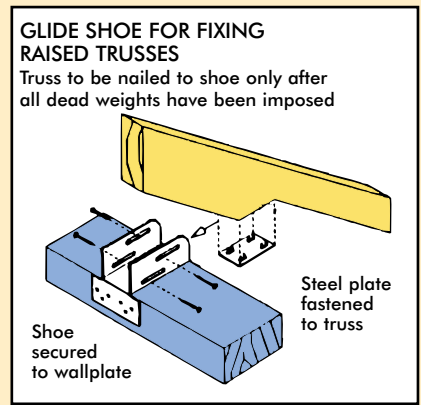
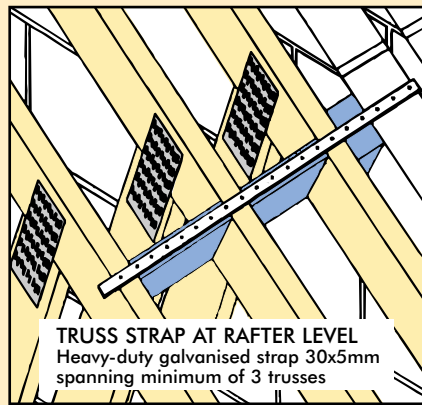
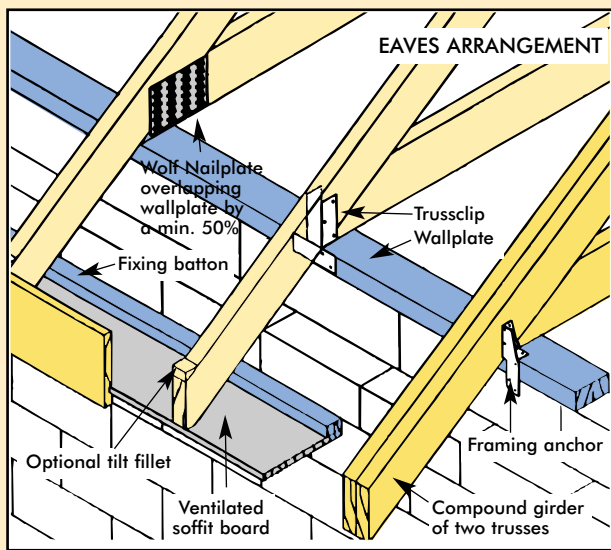

# Standard stability bracing

## MONOPITCH TRUSSED RAFTERS

Bracing for other types of roof trusses (eg. attic trusses) will require a special design. Please contact our design office.

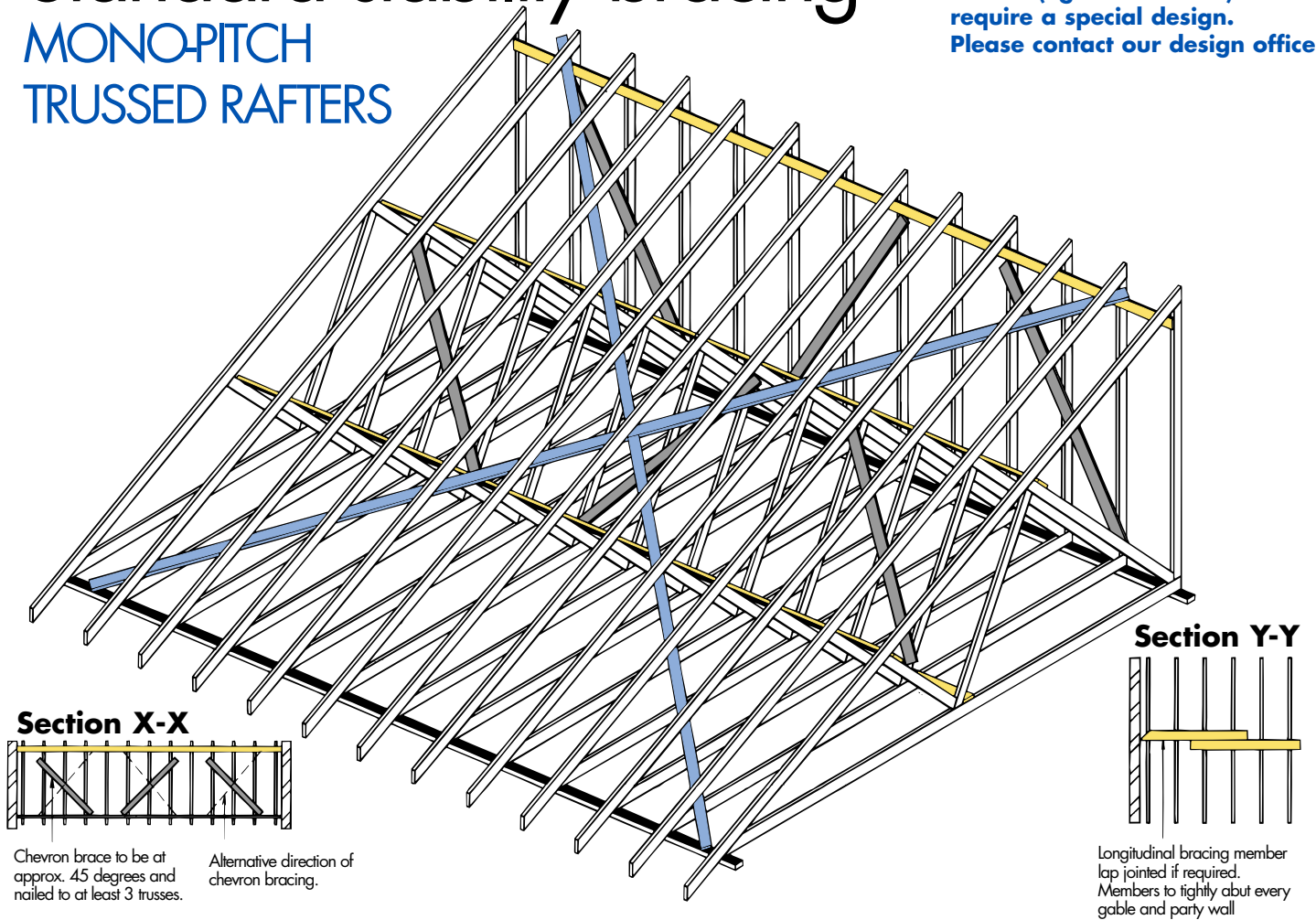

### Section W-W

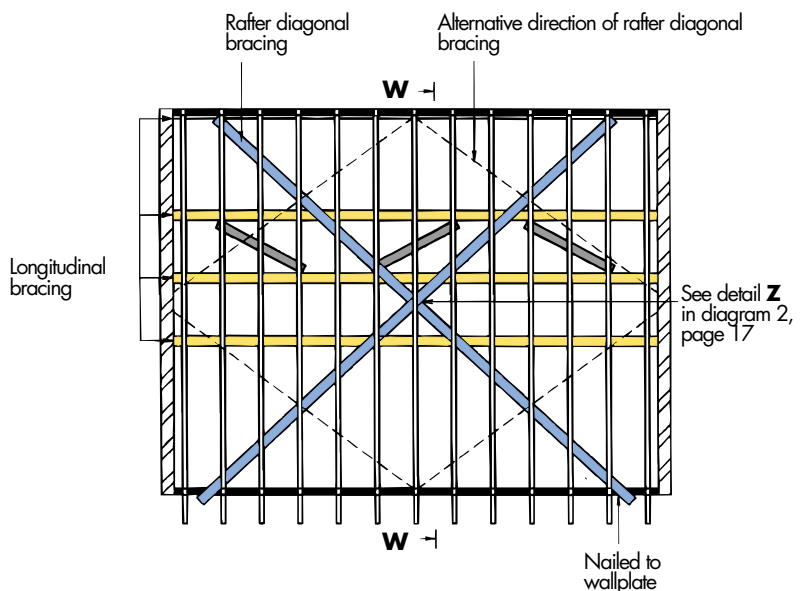
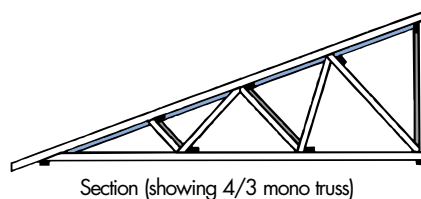
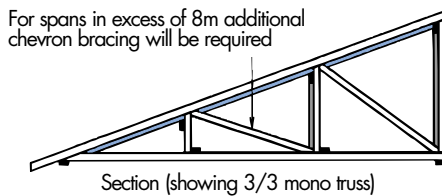
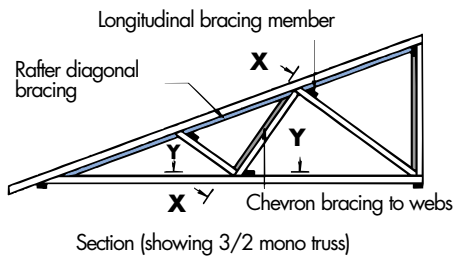

NOTE: Chevron bracing shown is not required on internal members of trusses for spans of 5m or less

Diagram 1. Standard bracing for rafter and web members of mono-pitch trussed rafters.

# Standard stability bracing

## DUO-PITCH TRUSSED RAFTERS

Bracing for other types of roof trusses (eg. attic trusses) will require a special design. Please contact our design office.

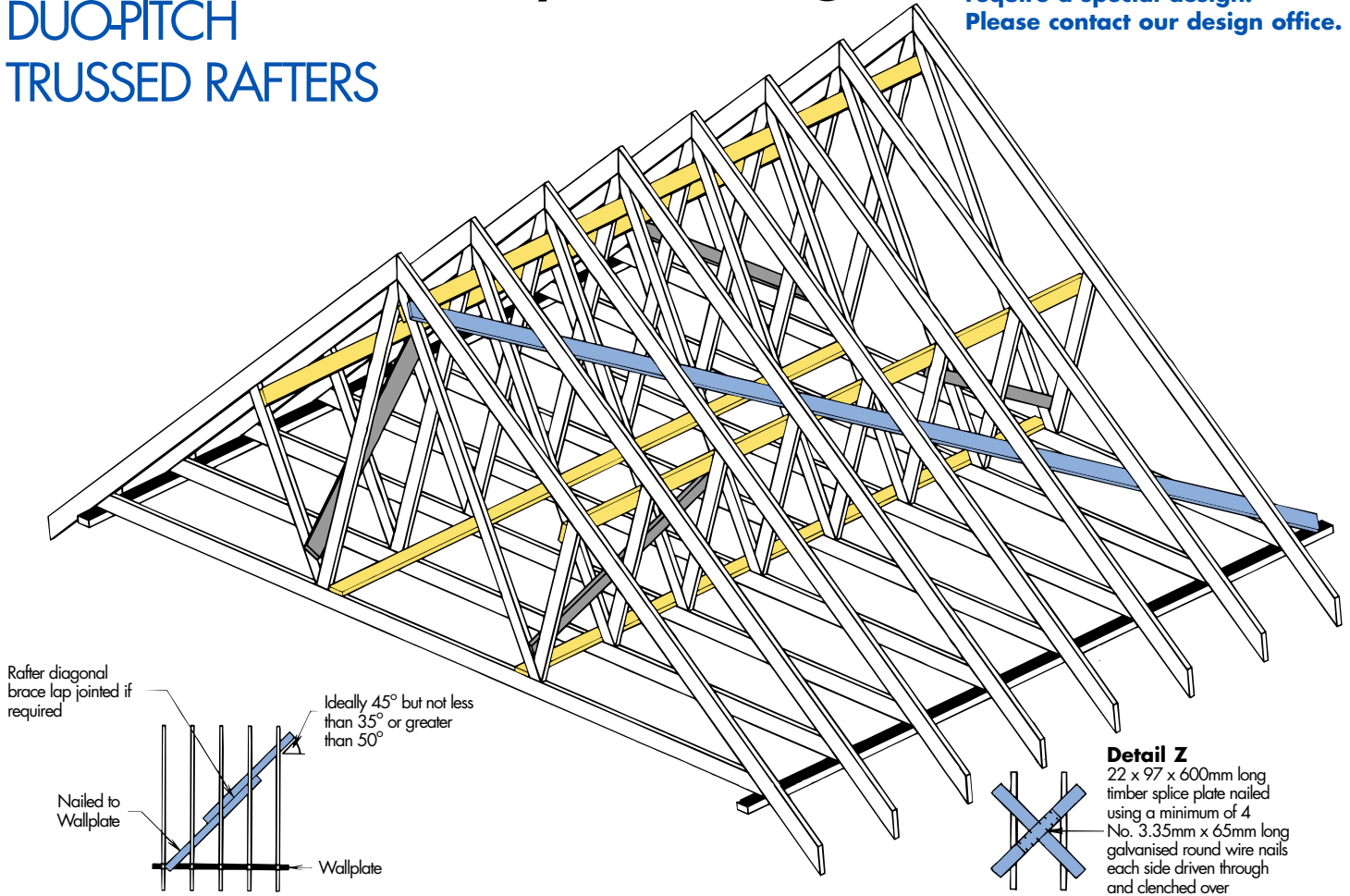

### Section X-X

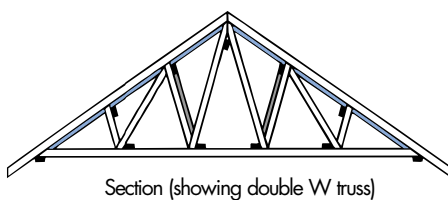
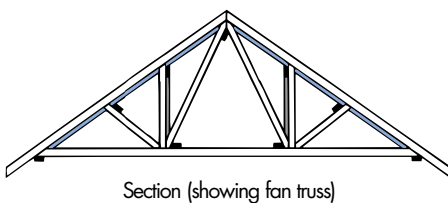
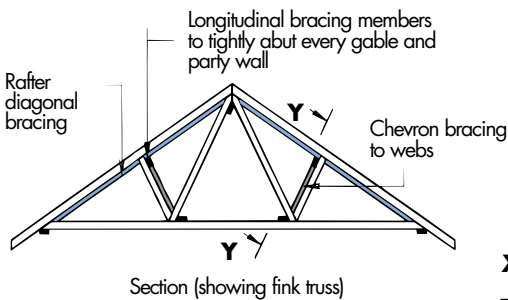

### Section Y-Y

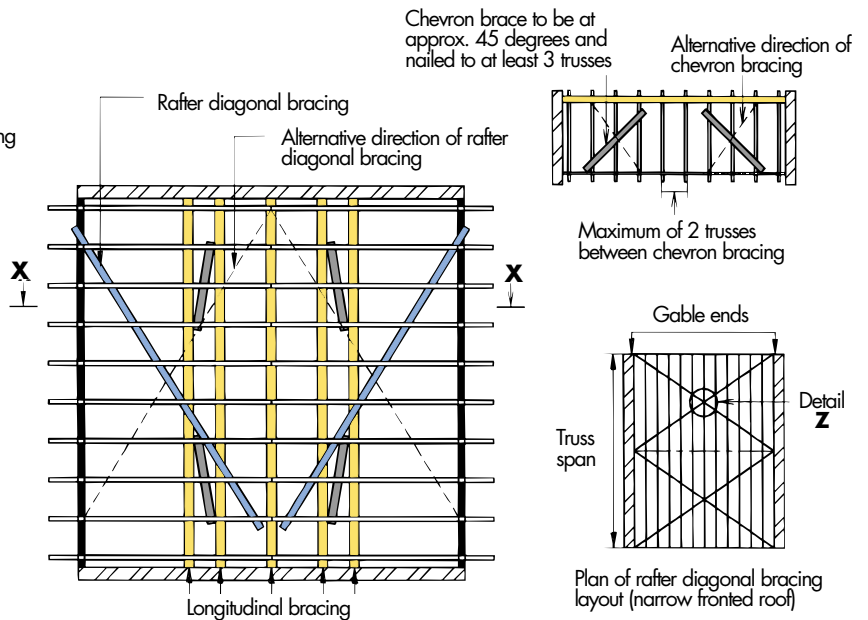

**NOTE:** Chevron bracing shown is not required on internal members of trusses for spans of **8m** or less.

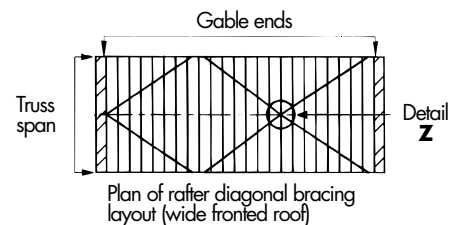
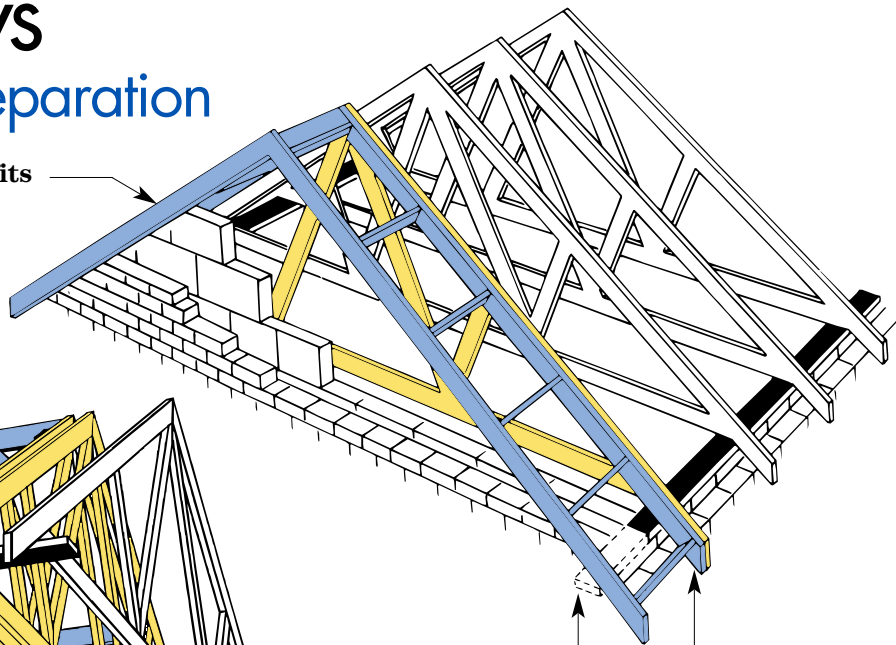

**Diagram 2. Standard bracing for rafter and web members of duo-pitch trussed rafters.**

# Gable ladders, hatches and chimneys

## Recommended preparation

**Bargeboards and Soffits** to be nailed directly to the gable ladder



**Gable Ladders** to be fixed directly to last truss with nails at 400mm centres

Wallplate may be extended over the gable ladder width for added support if required

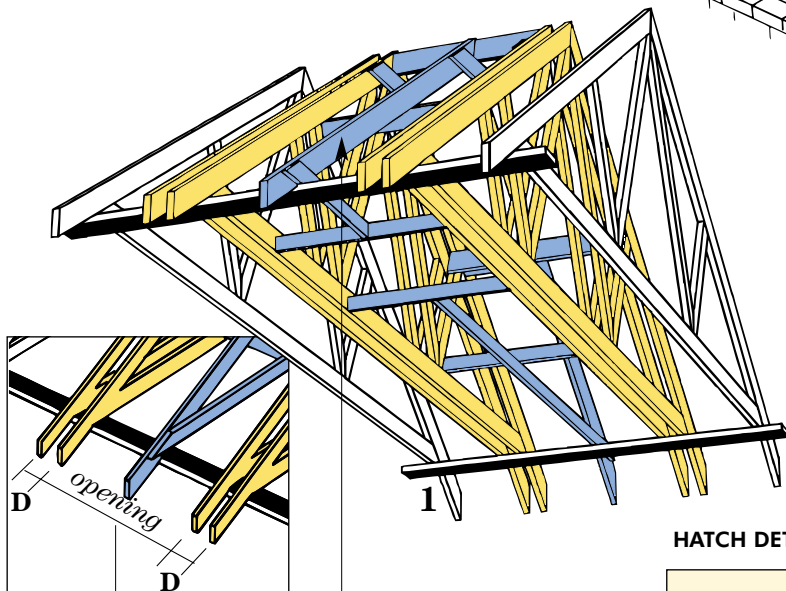

**HATCH DETAIL**

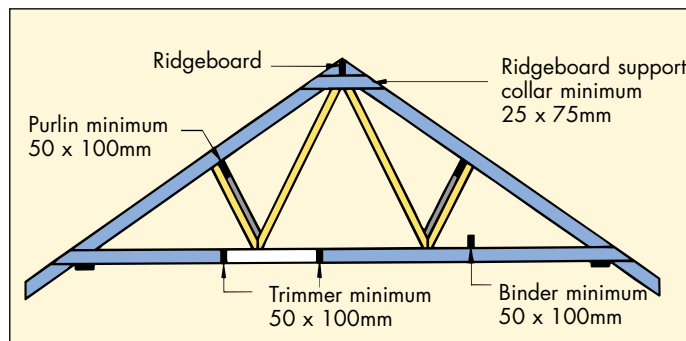

**Jack Rafter** 25mm deeper than trussed rafter and birdmouthed over wallplate

D max. is equal to twice the design truss spacing less the opening width

**Hatch and chimney openings:** Whenever possible hatch openings should be accommodated within the trussed rafter design spacing. When this is not possible the method illustrated 1 and 2 should be used.

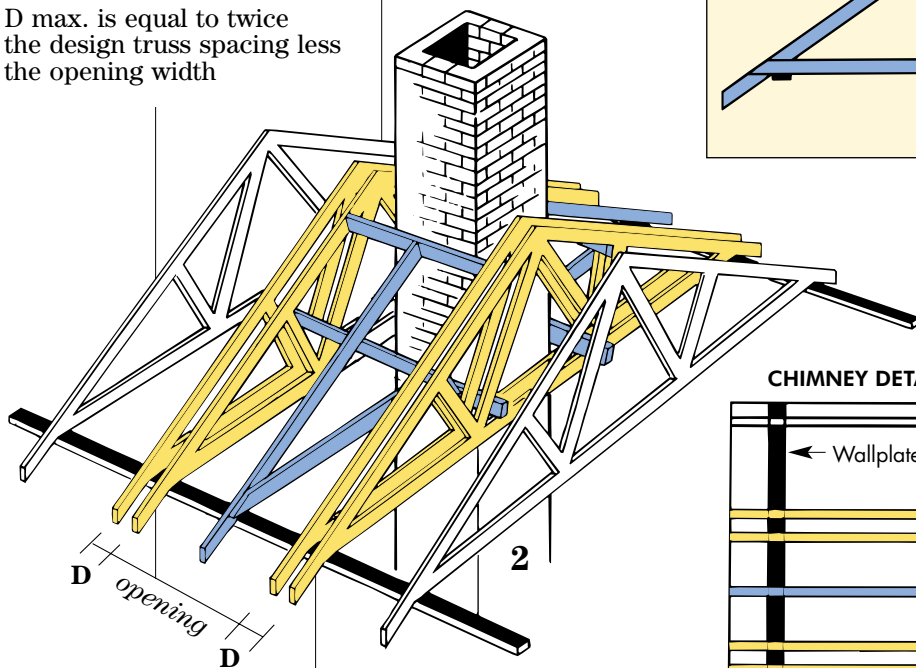

**CHIMNEY DETAIL**

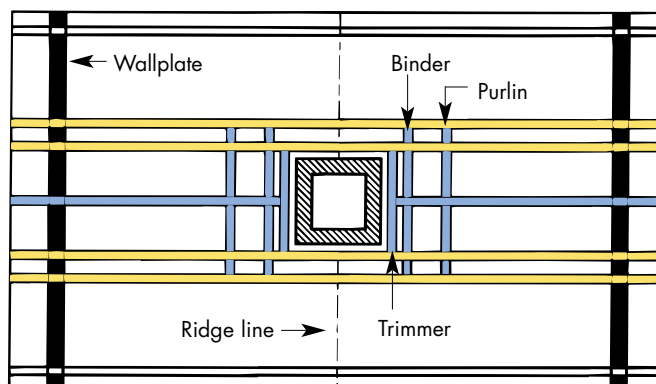

**Jack Ceiling Joist** nailed to side of jack rafter, size to match bottom chord of trussed rafter

All timbers must be at least 50mm clear of the chimney brickwork

# Water tanks

## Recommended preparation

Where tanks are to be supported by trussed rafters, the size, type and position of the tanks should be clearly indicated.

The trusses must be specifically designed to carry the extra weight which should be distributed over three or more trusses by the use of spreader beams. The loads should be applied as close as possible to the node points on the ceiling ties. The maximum load imposed by the tank and its contents must not exceed 450N at each adjacent ceiling tie node point. In such cases, the support members should be in accordance with the table below. In other cases where applicable, the support spreader beams should be designed to BS 5268: Part 2.

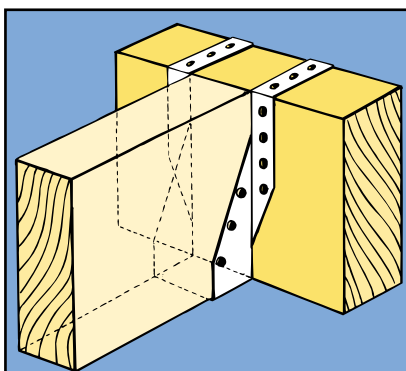
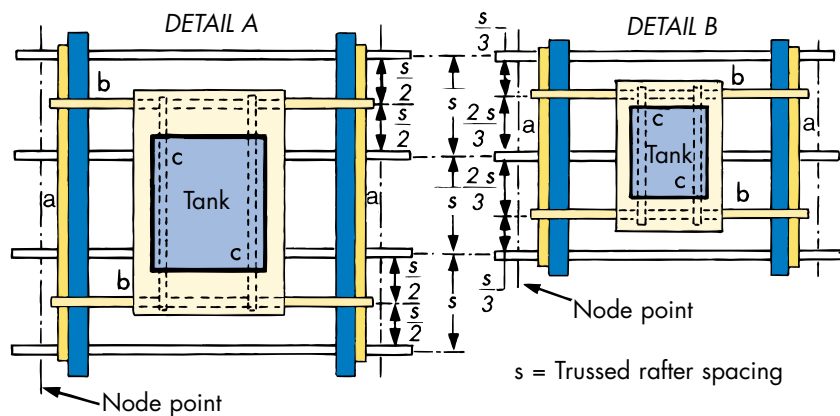
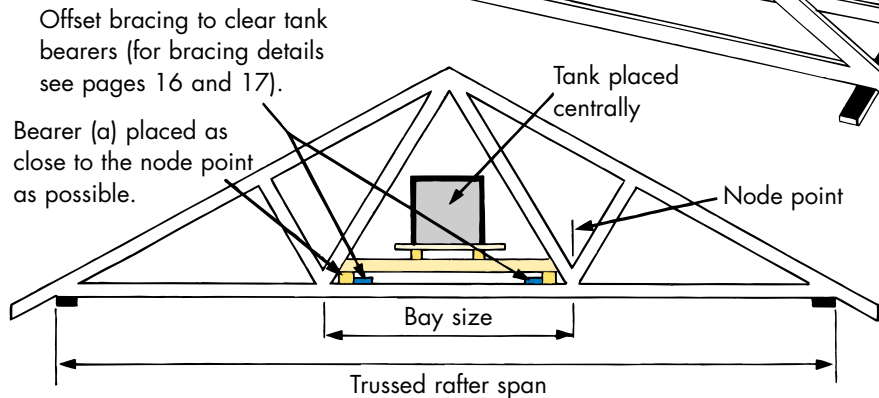
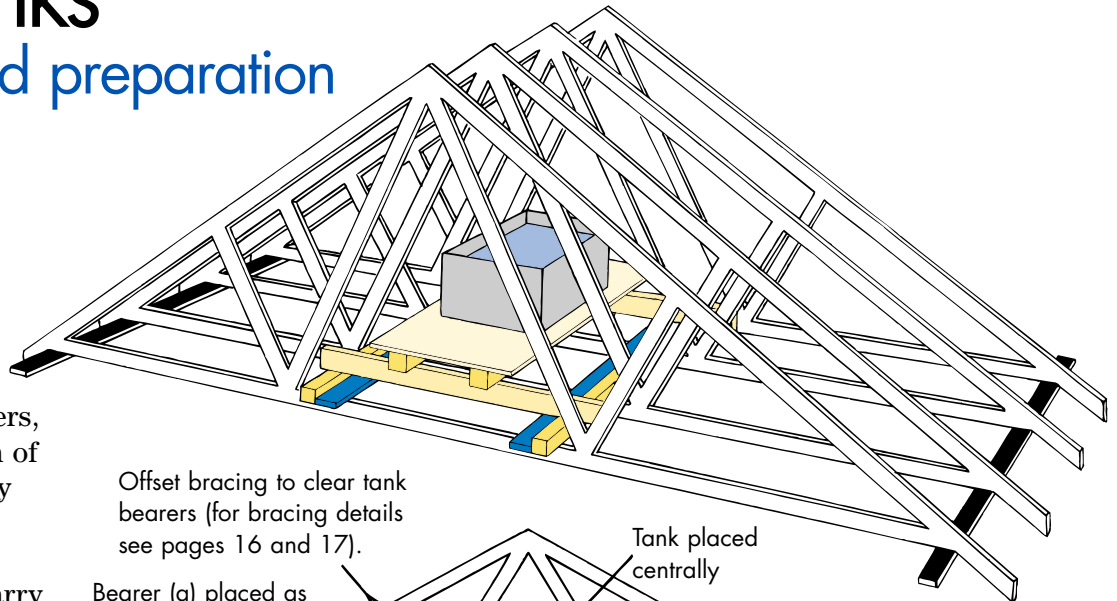

### ALTERNATIVE SUPPORT BETWEEN MEMBERS

Where space is limited this detail may be used between members (a) & (b) and (b) & (c) in order to gain head room. However a minimum clearance of 25mm above the ceiling lining should be allowed for possible deflection.

TABLE: SIZES FOR SUPPORT MEMBERS

Total tank capacity to marked waterline	Min. member sizes		Max. trussed rafter span for fink configuration m	Max. bay size for other configurations m
	a and c mm	b		
DETAIL A Not more than 300 L supported on four trussed rafters	47 x 72	2/35 x 97 or 1/47 x 120	6.50	2.20
	47 x 72	2/35 x 120 or 1/47 x 145	9.00	2.80
	47 x 72	2/35 x 145	12.00	3.80
DETAIL B Not more than 230 L supported on three trussed rafters	47 x 72	1/47 x 97	6.50	2.20
	47 x 72	2/35 x 97 or 1/47 x 120	9.00	2.80
	47 x 72	2/35 x 120 or 1/47 x 145	12.00	3.80

NOTE: Support members may be of any species with a permissible bending stress not less than that of European redwood/whitewood of GS or C16 stress grade.

# Fixings: anchorage, wallplate positions, care in preparation

## Application details

Careful erection, fixing and strapping is essential if a trussed rafter roof is to provide a sound platform for roof coverings and contribute effectively to the stability of the roof and gable ends.

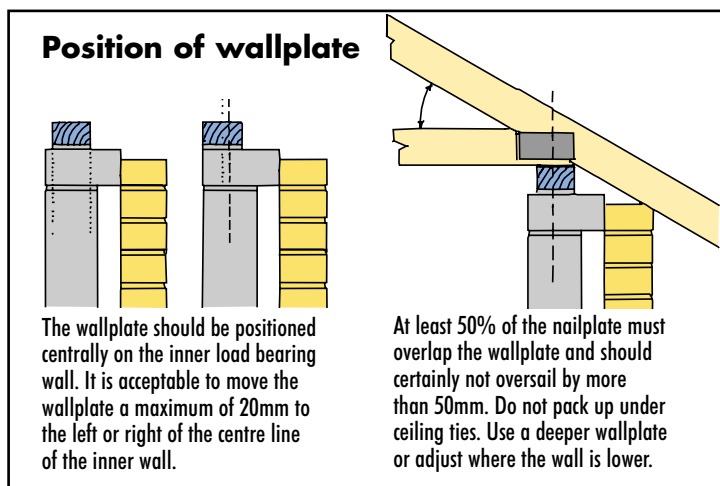

### Strapping gables to ceiling ties

Ceiling tie straps may be excluded from the specification if roof pitches are below 20°. Check with the building designer. If they are needed, fix as shown for truss straps, but attach to upper edge of the ceiling tie. Use a cranked strap to engage a vertical joint if horizontal courses do not coincide.

### Strapping at the separating wall

In addition to the normal strapping to walls, additional straps may have been specified to provide longitudinal bracing between roofs, these should be run over the top of the separating wall and fixed to the specified number of trusses on each side. Include noggings and packing to transmit loads properly.

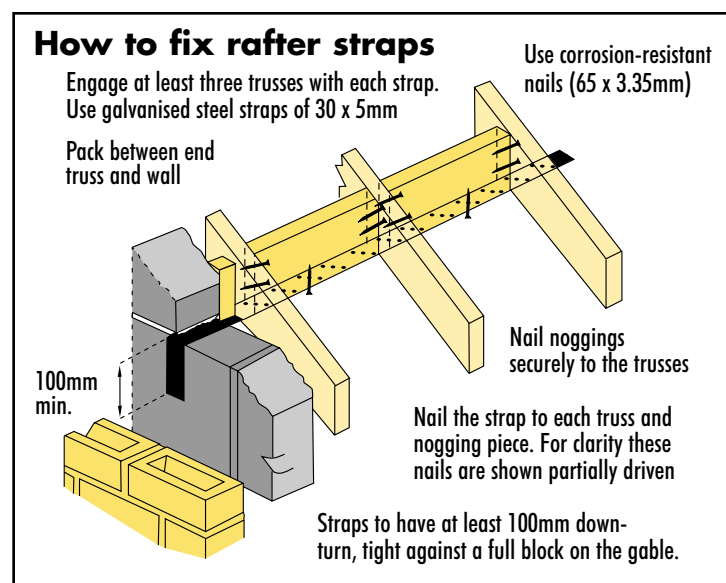

### Checks before erecting trussed rafters

- The cavity must be closed along the eaves line, either stopped with masonry or a cavity barrier.
- The wallplate is a minimum of 75mm x 50mm.
- That timber members and nailplates are not damaged.
- That trussed rafters are the correct span and can be fitted to wallplates without cutting.
- That truss weight information is known.
- That the timber is dry and sound, and the nailplates are free of corrosion.
- That there are no missing nailplates.
- None of the trussed rafters are visibly distorted.
- That there are no unapproved site repairs to trussed rafters. Or that any such repairs have been carried out under the direction of the truss designer.
- That positions for water tank and for chimney, and access openings are all clearly identified.
- That clear guidance is given on the number, size and corrosion resistance of straps, clips and all other fixings.

### Holding down roofs to walls

Roof to wall (vertical) strapping is not required unless the location of building construction is known to be wind stressed, then it is essential to carry out the roof designer's specifications. Lighter roof coverings in areas of higher wind load, require holding down straps as may be specified for brick/block construction. In extreme cases, the design may call for direct strapping of rafters to the walls (see illustration).

Straps are normally a minimum 30 x 2.5mm section galvanised steel, but any higher specification should be followed. The tops of straps should be nailed (three 30 x 3.75mm nails or more) to the wall plate, or the rafter in the case of a rafter to wall strap. When fixing to the wall, it is critical that the straps are long enough to run over the specified number of blocks, and that at least two of the fixings engage the last full block at the base of the strap.

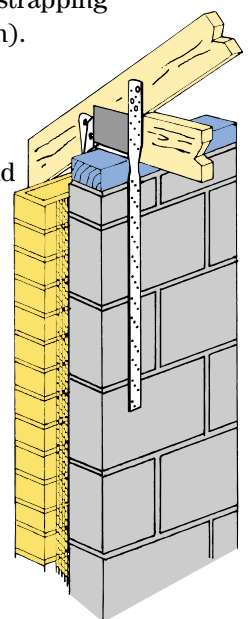

# Fixings: straps and clips

## Application details

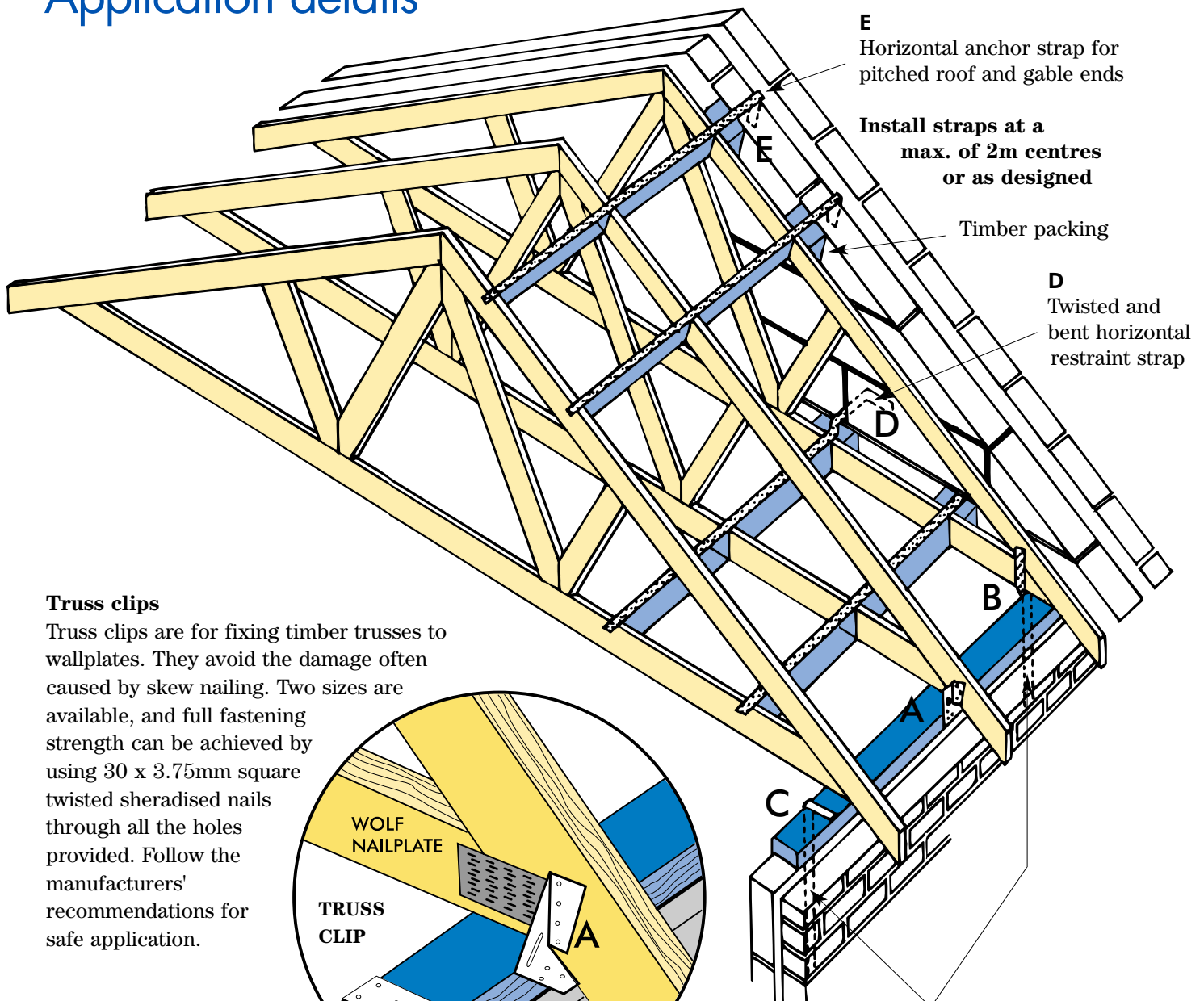

### Truss clips

Truss clips are for fixing timber trusses to wallplates. They avoid the damage often caused by skew nailing. Two sizes are available, and full fastening strength can be achieved by using 30 x 3.75mm square twisted sheradised nails through all the holes provided. Follow the manufacturers' recommendations for safe application.

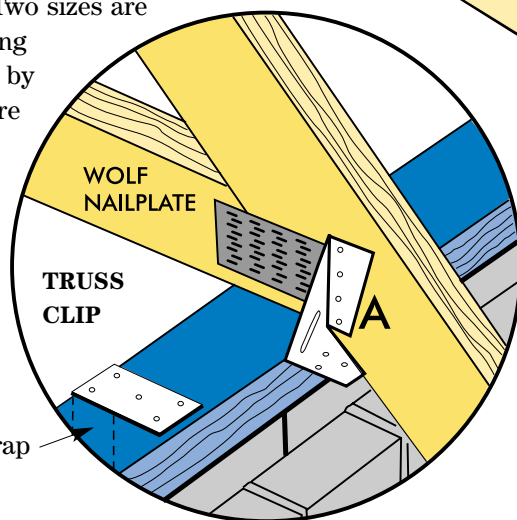

Wallplate anchor strap

### Horizontal and vertical restraint straps

All straps are manufactured from galvanised steel with holes punched at regular intervals along their length. Horizontal straps usually have 30 x 5mm section, and may also feature a combination of bends and edge twists according to requirements. Vertical straps have lighter loads and are usually 30 x 2.5mm section. They should all be used in accordance with Building Regulations and BS 5268 Part 3.

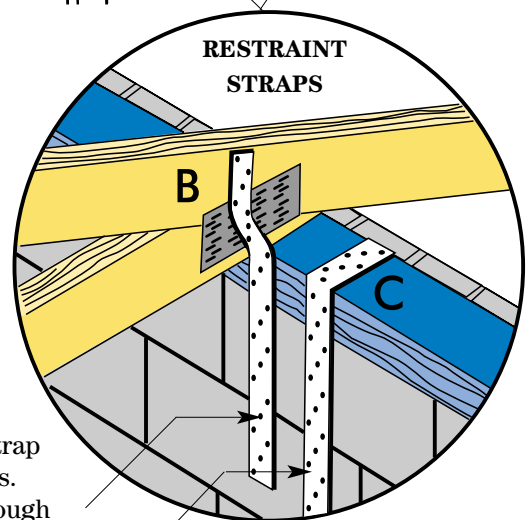

**B** Vertical anchor strap for trussed rafters. Avoid nailing through the nailplate.

**C** Vertical restraint strap for wallplate anchorage

# Fixings: shoes and hangers

## Application details

### Heavy-duty joist hanger to BS6178 Part 1

These are generally used to carry trusses or joists at masonry load bearing or fire break walls where careful consideration must always be given to the method of support. We would recommend that advice is obtained from the responsible Building Designer or Structural Engineer since in a number of cases special hangers may have to be manufactured. The Building Designer may also specify high density brick courses above and below the hangers to avoid crushing of blocks. The bearing length for these joist hangers is approx. 90mm.

### Heavy-duty girder to girder truss shoes

These are designed to support a secondary girder off the main girder ensuring that the loads are transferred efficiently. The shoe is usually fixed to the main girder (A) by means of 20mm bolts with washers under the bolt heads and nuts. The bearing length for these shoes is approx. 120mm.

NB. refer to manufacturers instructions for the correct application and procedure.

### Girder truss shoe and long legged hangers

Girder truss shoes are used to fix single trusses to compound girders or for other truss to truss connections. The bearing length is approx. 95mm.

When the girder chord supporting the shoe or hanger is less than the length of its side flanges, then a block must be introduced as shown (C) to prevent buckling. Long legged joist hangers (D) are used for timber to timber, or timber to truss connections. They are not suitable for truss to truss connections, and should NEVER be used for this purpose. The bearing length is up to 50mm.

Metal fixings used in timber roof structures should have safe working loads which can be substantiated by freely available technical reports in accordance with BS 6178 and TRADA recommendations. **They should always have a manufacturer's mark and show the certified safe working load.**

It is strongly recommended that timber to timber fixings and timber to brick fixings should be supplied by the Roof Truss Fabricator, and delivered to site with the trusses.

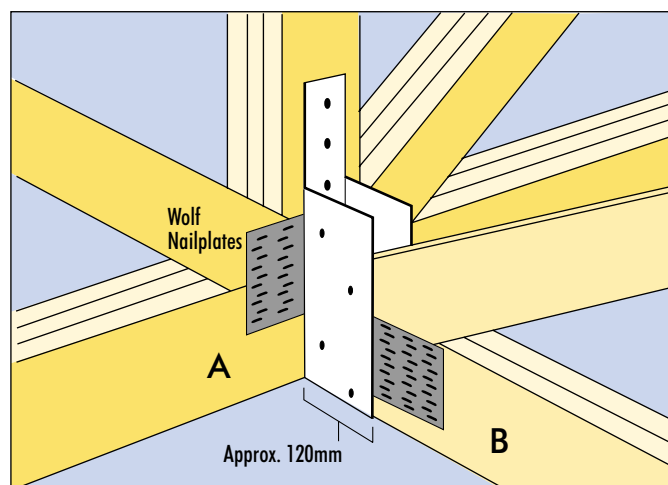
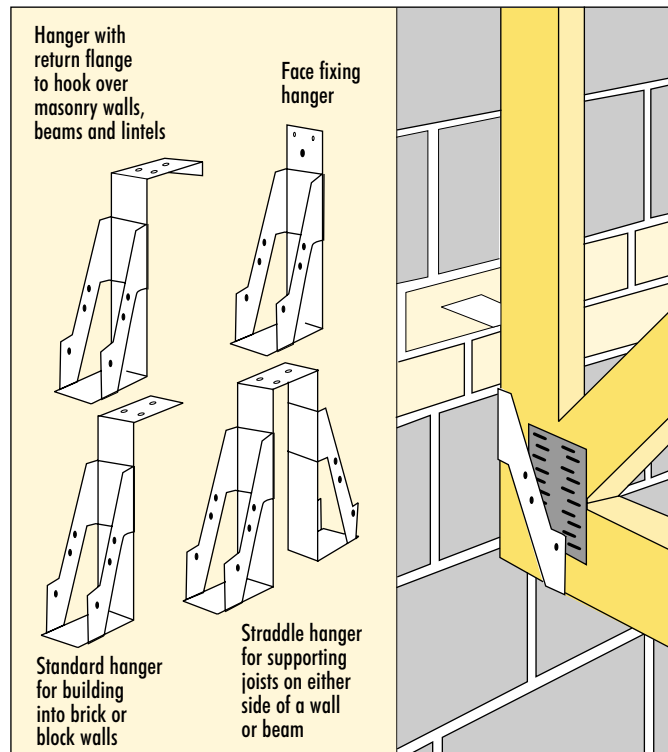

Incoming trusses (B) supported by heavy duty shoes and hangers, should be notched to provide a smooth ceiling line.

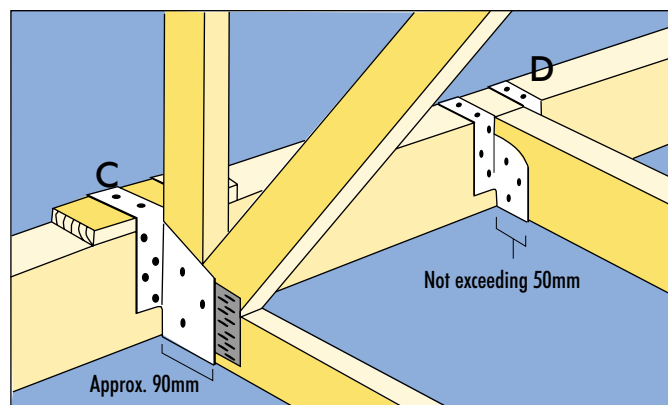

N.B. For all the hangers and shoes described above, every fixing hole requires either a 30 x 3.75mm square twisted sheradised nail, or a 20mm bolt.



# Ventilation and insulation

## Construction details

When warm, moist air comes into contact with cold surfaces, condensation occurs. Because of the changes in house design, central heating and some of the building materials used, roof spaces have a tendency to become colder and less ventilated. This has resulted in an increase in water vapour in them. The problem is that trussed rafters do not behave well under damp conditions, and there is a danger that after a prolonged period in these conditions the timber strength will reduce, rot will be encouraged in the members and the nailplates could be adversely affected.

**In order to reduce water vapour in the roof space, two methods can be employed.**

**Firstly**, to remove water vapour which has gained access to the roof space, there must be adequate ventilation. Useful information can be obtained from the current issue of BS 5250: *The Control of Condensation in Dwellings*. For all roofs above 15 degree pitch, ventilation openings equivalent to a continuous opening of 10mm should be provided along two opposite sides of the roof. Below 15 degrees this figure should be 25mm. Thermal insulation should be laid above ceilings to ensure that the temperature is maintained above dewpoint

at ceiling level. Although the insulation should be laid right up to the eaves, a gap should be left to ensure that free flow of air is not hindered. This can be achieved by an insulation overlay tray. It is possible to permit a certain amount of extra ventilation if the felting or tile underlays are permeable to water vapour or laid such that vapour can pass through the joints.

**Secondly**, a continuous vapour barrier should be fixed to ceiling level beneath the insulation to prevent water vapour entering the roof through the ceiling of the upper floor. At the same time, all access hatches, pipe and ceiling light holes should be sealed with a suitable filler. Wall head cavities should be closed to prevent water vapour entering either through the inner leaf or by evaporation of rain water through the outer leaf. All water tanks and holes through which pipes pass, should be covered and sealed. This procedure is particularly recommended for indoor swimming pools, saunas, etc.

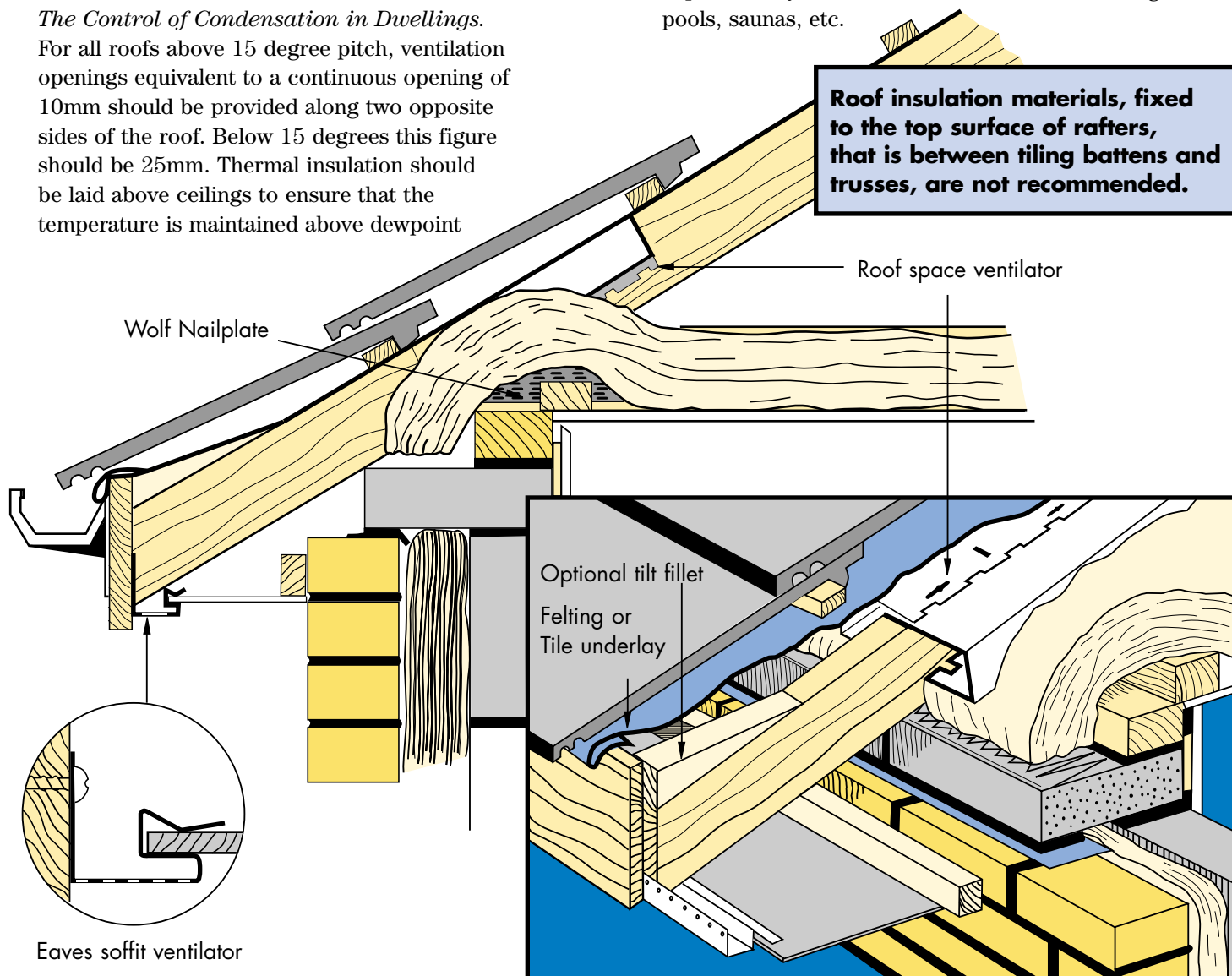

# Glossary of terms

## **APEX/PEAK**

The uppermost point of a TRUSS.

## **ATTIC TRUSS/ROOM-IN-THE-ROOF**

A truss which forms the top storey of a dwelling, but allows the area to be habitable by leaving it free of internal WEB members. This will be compensated by larger timber sizes elsewhere (see page 10).

## **BARGEBOARD**

Board fitted to conceal roof timbers at GABLE END.

## **BATTENS**

Small timber members spanning over trusses to support tiles, slates, etc.

## **BEARER**

A member designed to distribute loads over a number of trusses.

## **BEARING**

The part of a truss receiving structural support. This is usually a WALLPLATE but can be an internal wall etc.

## **BINDER**

A longitudinal member nailed to trusses to maintain correct spacing.

## **BIRDSMOUTH**

A notch in the underside of a RAFTER to allow a horizontal seating at the point of support (usually used with RAISED TIE TRUSSES - see page 9).

## **BLOCKING**

Short timbers fixed between chords to laterally brace them. They should be at least 70% of the depth of the CHORDS.

## **BOBTAIL**

A truss type formed by truncating a normal triangular truss.

## **BOTTOM CHORD**

See CEILING TIE.

## **BRACING**

This can be Temporary, Stability or Wind Bracing which are described under these headings.

## **BUILDING DESIGNER**

The person responsible for the structural stability and integrity of the building as a whole.

## **CAMBER**

An upward vertical displacement built into a truss in order to compensate for deflection which might be caused by the loadings.

## **CANTILEVER**

The part of a structural member or TRUSS which extends beyond its bearing.

## **CEILING TIE**

The lowest member of a truss, usually horizontal which carries the ceiling construction, storage loads and water tank.

## **CHEVRON BRACING**

Diagonal bracing nailed to the truss in the plane of the specified webs to add stability.

## **CHORDS**

Refer to the Top and Bottom Chords which are respectively the RAFTER and CEILING TIE.

## **CONCENTRATED LOAD**

A load applied at a point.

## **CONNECTOR PLATE/FASTENER**

See NAILPLATE.

## **CRIPPLE RAFTER**

See JACK RAFTER.

## **DEAD LOAD**

The load produced by the fabric of the building, always long term, (see DESIGN LOADS).

## **DEFLECTION**

The deformation caused by the loads.

## **DESIGN LOADS**

The loads for which the unit is designed. These consider the duration of the loads – long term, medium term, short term and very short term.

## **DUO/DUAL PITCH TRUSS**

A truss with two rafters meeting at the APEX but not necessarily having the same PITCH on both sides.

## **DWANGS**

See NOGGINGS.

## **EAVES**

The line where the rafter meets the wall.

## **EAVES JOINT/HEEL**

The part of the truss where the rafter and the ceiling tie intersect. This is usually where the truss is supported.

**EXTENDED RAFTER**

See **RAISED TIE TRUSS**.

**FASCIA**

Horizontal board fitted along the length of the building to the edge of the truss overhangs.

**FASTENER**

See **NAILPLATE**.

**FINK TRUSS**

The most common type of truss used for dwellings. It is duo-pitch, the rafters having the same pitch. The webs form a letter W.

**FIRING PIECE**

A tapered timber member used to give a fall to flat roof areas.

**FRENCH HEEL**

An **EAVES** joint where the rafter sits on the ceiling tie.

**GABLE END**

The end wall which is parallel to the trusses and which extends upwards vertically to the rafters.

**GABLE LADDER**

Components used to form an overhang at the gable end.

**GIRDER TRUSS**

A truss made up of two or more fixed together and designed to take exceptional loads, such as those imposed by other trusses fixed to it.

**HEEL**

See **EAVES JOINT**.

**HIP BOARD**

A member sloping from ridge to corner in a **HIP END** construction.

**HIP END**

An alternative to a **GABLE END** where the end wall finishes at the same height as the adjacent walls. The roof inclines from the end wall, usually (but not always) at the same **PITCH** as the main trusses.

**HIP SET**

The trusses, girders and loose timbers required to form a hip end.

**HORN/NIB**

An extension of the ceiling tie of a truss (usually monos or bobtailed trusses) which is built into masonry as a bearing.

**IMPOSED LOAD**

The load produced by occupancy and use including storage, inhabitants, moveable partitions and snow, but not wind. Can be long, medium or short term.

**INTERNAL MEMBER**

See **WEB**.

**INTERSECTION**

The area where roofs meet.

**JACK RAFTER**

An infill rafter completing the roof surface in areas such as corners of **HIP ENDS** or around chimneys.

**LIVE LOAD**

Term sometimes used for **IMPOSED LOADS**.

**LONGITUDINAL BRACING**

Component of **STABILITY BRACING**.

**LOOSE TIMBER**

Timbers not part of a truss but added to form the roof in areas where trusses cannot be used.

**MONO-PITCH TRUSS**

A truss in the form of a right-angled triangle with a single rafter.

**NAILPLATE**

Metal **PLATE** having integral teeth punched from the plate material. It is used for joining timber in one plane with no overlap. It will have an Agrément Certificate and will be manufactured, usually, from galvanised steel. It is also available in stainless steel.

**NIB**

See **HORN**.

**NODE**

Point on a truss where the members intersect.

**NOGGINGS**

Timber pieces fitted at right angles between the rafters and ceiling ties to form fixing points.

**OVERHANG**

The extension of a rafter or ceiling tie of a truss beyond its support or bearing.

# Glossary

## **PART PROFILE**

See **BOBTAIL**.

## **PEAK**

See **APEX**.

## **PERMISSIBLE STRESSES**

Design Stresses for grades of timber published in BS 5268: Part 2: 1988.

## **PITCH**

The angle of the rafter to the horizontal, measured in degrees.

## **PLATE**

See **NAILPLATE**.

## **PLATE LOCATION/POSITION**

### **TOLERANCE**

Acceptable deviation from specified location for the plate on a truss. This is usually 5mm but can be specified greater.

## **POLE PLATE**

Timber used in cantilevered hips to support loose timbers.

## **PURLINS**

Timber members spanning over trusses to support cladding or between trusses to support loose timbers.

## **QUARTER POINT**

The point on a rafter where the strut intersects in a **FINK TRUSS**.

## **QUEEN**

Internal member (web) which connects the **APEX** to a third point on a **FINK TRUSS**.

## **RAFTER**

The uppermost member of a truss which normally carries the roof covering.

## **RAFTER DIAGONAL BRACING**

Component of **STABILITY BRACING**.

## **RAISED TIE TRUSS**

A truss which is supported at a point on the rafter which is beyond the point where the rafter meets the ceiling tie.

## **REDUCING TRUSSES**

See **VALLEY FRAMES**.

## **REMEDIAL DETAIL**

A modification produced by the **TRUSSED RAFTER DESIGNER** to overcome a problem with the truss after its manufacture.

## **RETURN SPAN**

The span of a truss being supported by a girder.

## **RIDGE**

The line formed by the truss apexes.

## **RIDGEBOARD**

Timber running along a ridge and sandwiched between loose rafters.

## **ROOF DESIGNER**

The person responsible for the roof structure as a whole, and who takes into account its stability and capability of transmitting wind forces on the roof to suitable load-bearing walls.

## **ROOM-IN-THE-ROOF**

See **ATTIC TRUSS**.

## **SCAB**

Additional timber fitted to the side of a truss to effect a local reinforcement, particularly in **RAISED TIE TRUSSES**.

## **SETTING-OUT-POINT**

The point on a truss where the undersides of the rafter and ceiling tie meet.

## **SKEW NAILING**

A method of fixing trusses to the **WALLPLATE** by driving nails at an angle through the truss into the wallplate which is generally not recommended. (See **TRUSS CLIP**.)

## **SOFFIT**

Board fixed underneath **EAVES** overhang along the length of the building to conceal timbers.

## **SPAN**

Span over wallplates is the distance between the outside edges of the two supporting wallplates. This is usually the overall length of the ceiling tie.

## **SPANDREL PANEL**

A timber frame, triangular panel forming gable wall above ceiling line.

## **SPLICE**

A joint between two members in line using a **NAILPLATE** or glued finger joint

## **SPREADER BEAM**

See **BEARER**.

## **STABILITY BRACING**

An arrangement of additional timbers fixed in the roof space to provide lateral support to the trusses.

## **STRAP**

Metal component designed to fix trusses and wallplates to walls.

## **STRUT**

Internal member connecting the third point and the quarter point on a FINK TRUSS.

## **STUB END**

See BOBTAIL.

## **TEMPORARY BRACING**

An arrangement of diagonal loose timbers installed for safety during erection. Often incorporated with permanent STABILITY and WIND BRACING structures.

## **THIRD POINT**

Point on the ceiling tie where the internal webs meet in a FINK TRUSS.

## **TIMBER STRESS GRADING**

The classification of timber into different structural qualities based on strength (see BS 4978: 1988).

## **TOP CHORD**

See RAFTER.

## **TRADA QUALITY ASSURANCE SCHEME**

Quality control method in truss manufacture administered by the Timber Research and Development Association.

## **TRIMMER**

A piece of timber used to frame around openings.

## **TRUSS/TRUSSED RAFTER**

A lightweight framework, generally but not always triangulated, placed at intervals of 600mm to support the roof. It is made from timber members of the same thickness, fastened together in one plane using nailplates or plywood gussets.

## **TRUSSED RAFTER DESIGNER**

The person responsible for the design of the TRUSSED RAFTER as a component, and for specifying the points where bracing is required.

## **TRUSS CLIP**

A metal component designed to provide a safe structural connection of trusses to wallplates. Also to resist wind uplift and to remove the damage caused by SKEW NAILING.

## **TRUSS SHOE**

A metal component designed to provide a structural connection and support for a truss to a girder or beam.

## **UNIFORMLY DISTRIBUTED LOAD**

A load that is uniformly spread over the full length of the member.

## **VALLEY BOARD**

A member raking from incoming RIDGE to corner in a valley construction.

## **VALLEY FRAMES/SET**

Infill frames used to continue the roofline when roofs intersect.

## **VERGE**

The line where the trussed rafters meet the gable wall.

## **WALLPLATE**

A timber member laid along the length of the load-bearing walls to support the trusses. This must be at least 75mm wide.

## **WEBS**

Timber members that connect the rafters and the ceiling tie together forming triangular patterns which transmit the forces between them.

## **WIND BRACING**

An arrangement of additional timbers, or other structural elements in the roof space, specially designed to transmit wind forces to suitable load-bearing walls.

## **WOLFCHORDS**

Are composite beams consisting of two timbers, plated together to form a deeper section. They can be used as simple beams or incorporated into a trussed rafter to reinforce a highly stressed member. They are often used in raised tie trusses. They are sometimes referred to by others as 'Superchords, Stackchords or Twinchords'.

# Information required

Certain information is required by us so that we can produce accurate and economical designs to your exact requirements. All you need do is to send us the drawings of a scheme. These may be sent as a DXF (or RCS) file. Failing this, your sketches or advanced drawings should contain dimensions, and show elevations, plans etc. Site plans are also helpful to show any relationship between the different building designs conceived.

<b>A If a Component Only Service is required, the following information will be necessary:</b>	
1	Number of trusses
2	Spacing
3	Span over wallplates
4	Pitch, pitches or rise
5	Type and size of overhangs
6	Profile and camber – if required
7	Type or weights of roof covering including tiles, sarking, insulation and ceiling materials
8	Water tank size and position
9	Preservative treatment
10	Whether there is a need for special timber sizes or special nailplates, eg. stainless steel
11	Date and delivery required and delivery schedule
12	Special eaves details – if any
13	Quantity and size of gable ladders
14	Fixings required

<b>B If a whole Roof Design Service is required, the following extra details will be necessary:</b>	
1	Roof or house style reference
2	Requirements for clear roof space
3	Eaves height and location of building together with any unusual wind and weather conditions. Also Ordinance Survey reference if known
4	Types of Hip System or other roofscape required including gable ends and verges
5	Extra loads to be considered for service pipes, ducting etc.
6	Positions and sizes of hatches, chimneys, dormers and other openings
7	Details and positions of the supports for the roof
8	Site visits
9	Is a collateral warranty required?
10	Health & Safety file for site, including any known hazards

## Wolf Group of Companies

Wolf Systembau was started by Johann Wolf in 1966 in Scharnstein, Austria. The original activities of the company were construction within the agricultural industry. This consisted of concrete silos and buildings constructed of timber, steel and concrete. The company then expanded into other areas of the construction industry such as industrial, commercial and domestic buildings, manufacturing machinery for sawmills, timber frame wall panels and roof trusses, as well as harvesting timber from their own forests.

The company is now located in over 20 countries worldwide, and is still privately owned by Johann Wolf and his family. All of the Group's operations are construction related.

Wolf Systems has a network of over 50 experienced Trussed Rafter manufacturers in the United Kingdom and Ireland, supported by our comprehensive design and software, and specialist engineering office. These manufacturers will be pleased to assist in resolving any design or supply issues for any complexity of roof, large or small.

## Other Products and Services



### easi-joist® metal web floor joists

Metal web joists with open web design for easier, cheaper and faster installation of services. Improved engineered designs, and site specific joists meaning faster erection and no site wastage. Reduced timber content gives minimal shrinkage, therefore a quieter, longer lasting floor system. Overall cost savings through design and erection time as well as service installation.



### KeyBuild® Timber Frame Software

KeyBuild® from Keymark is the only software that integrates and automates all of the major functions that take place when specifying and engineering the building components and materials in timber frame construction.

From design through engineering to final output and management information, KeyBuild® does it all.



### smartroof®

smartroof® is an evolutionary interlocking panel system that will change future thinking on room in the roof design and construction. Conceived specifically to solve the problems associated with traditional room in the roof techniques it offers the designer, the builder and the homeowner:

100% roof space utilisation, unique window versatility & rapid erection.

The recommendations in this Technical Manual are given in good faith and in the interests of good building practice, but without liability in any way. We are grateful to the British Standards Institution for permission to reproduce extracts from BS 5268. Copies of the British Standards publications are available from the British Standards Institution, Milton Keynes MK14 6LE.

We also acknowledge the permission granted by the Building Research Establishment for reproducing extracts from their leaflet: Good Building guide 16, 'Erecting, fixing and strapping trussed rafter roofs'. Copies of this leaflet and also GBG 8 'Bracing trussed rafter roofs', may be obtained from the BRE Bookshop, Watford WD2 7JR.





**Wolf Systems Limited** Shilton Industrial Estate, Shilton, Coventry CV7 9QL  
T 0044 (0)2476 602303  
F 0044 (0)2476 602243  
E [mail@wolfsystem.co.uk](mailto:mail@wolfsystem.co.uk)  
[www.wolfsystem.co.uk](http://www.wolfsystem.co.uk)

